

CENS.com Digital Magazines

Apr. 15, 2018 Volume 02

Auto Parts



New Era for Auto Parts



Hwang Yu Offers Quality
Steering Parts to Achieve Safety,
Reliability & Happiness



Guide to E-magazine

Content Sections

CENS.com

Access to CENS.com for more information, industry news & reports.



Online Product Index

Find quickly product categories of interest.



Advertiser Index

Find easily suppliers of interest.



Articles

Find here industry news, reports, and editorial articles.



For details on suppliers & products

Simply use hyperlink icons:

Inquire Now

Click **Inquire Now** to safely, quickly connect to online inquiry form for the advertiser/supplier.

Webpage

Click **Webpage** to connect to the introduction of the advertiser/supplier.



Guide to E-magazine

Content Sections

CENS.com

Access to CENS.com for more information, industry news & reports.



Online Product Index

Find quickly product categories of interest.



Advertiser Index

Find easily suppliers of interest.



Articles

Find here industry news, reports, and editorial articles.



For details on suppliers & products

Simply use hyperlink icons:

Inquire Now

Click **Inquire Now** to safely, quickly connect to online inquiry form for the advertiser/supplier.

Webpage

Click **Webpage** to connect to the introduction of the advertiser/supplier.



Index

A-BELT-LIN INDUSTRIAL CO., LTD.	152
A-ONE PARTS CO., LTD.	81
A-ONE PARTS CO., LTD.	98
A-ONE PARTS CO., LTD.	99
ADESCO INDUSTRIAL CO., LTD.	91
AL FORGE TECH CO., LTD.	82
ALTEZZA CO., LTD.	83
APACH INDUSTRIAL CO., LTD.	181
ARCON LTD.	182
ATOZ-PULLMAN CO., LTD.	177
AURORAL SINTER METALS CO., LTD.	22
AUTO PARTS INDUSTRIAL LTD.	122
AUTOPAX SUPPLIES, LTD.	132
BAO CHUAN INDUSTRIAL CO., LTD.	100
BAOCHENG ENTERPRISE CO., LTD.	16
CAR FULL ENTERPRISE CO., LTD.	123
CAR WAY CO., LTD.	153
CHAIN BIN ENTERPRISE CO., LTD.	183
CHANG LOON INDUSTRIAL CO., LTD.	184
CHEMEX TECHNOLOGY INC.	197
CHIA-LUNN INDUSTRIAL CO., LTD.	185
CHIEN LI ENTERPRISE CO.	72
CHIN CHIH METAL INDUSTRIAL CO., LTD.	23
CHIN HUNG INDUSTRIAL CO., LTD.	124

Index

CHIN LANG AUTOPARTS CO., LTD.	62	GIANTLIGHT TRAFFIC SUPPLIES INSTRUMENT CO., LTD.	135
CHING MARS CORPORATION	133	GLOSO TECH. INC.	53
CHUAN JIEEN ENTERPRISE CO., LTD.	24	GOLDEN BLOOM LTD.	54
CHUAN LIH FA MACHINERY WORKS CO., LTD.	199	GOLDEN WARE INT'L INC.	29
CHUMMY VEHICLE PARTS INC.	106	GOOD SUCCESS CORP.	154
CHYUAN CHANG INDUSTRIAL CO., LTD.	51	GOODTIME RUBBER CO., LTD.	127
DELTA PLASTICS CO., LTD.	165	GRACE NEWS INC.	186
DEMAX ENTERPRISE CO., LTD.	25	GRAND FORGING INDUSTRIES CO., LTD.	30
DEUSIC AUTOPARTS CO., LTD.	52	HANN KUEN MACHINERY & HARDWARE CO., LTD.	200
DITERNA AUTO PARTS CO., LTD.	26	HANS TOOL INDUSTRIAL CO., LTD.	187
EAGLE EYES TRAFFIC INDUSTRIAL CO., LTD.	129	HENG FU INDUSTRIAL CO., LTD.	120
ELEM TECHNOLOGY CO., LTD.	169	HIEVER CO., LTD.	188
ENERGY SKIP ENTERPRISE CO., LTD.	63	HOLI INDUSTRY CO., LTD.	31
ESUSE AUTO PARTS MFG. CO., LTD.	134	HOWELL AUTO PARTS & ACCESSORIES LTD.	155
EVER PIONEER CORP.	170	HSI TO TSUN ENTERPRISE CO., LTD.	65
EVER PIONEER CORP.	171	HSIANG LUN INTERNATIONAL CORP.	32
FAIR SUN INDUSTRIAL CO., LTD.	27	HSIN YI CHANG INDUSTRY CO., LTD.	156
FONG SHUN MACHINERY CO., LTD.	101	HUA SHENG AUTOMOTIVE LTD.	130
FORSA ENTERPRISES CO., LTD.	102	HUNYO CO., LTD.	121
FU-SHEN INDUSTRIAL CO., LTD.	92	HWA LI INDUSTRIAL CO., LTD.	136
FUJITECH MOTOR PARTS CO LTD.	21	HWANG YU AUTOMOBILE PARTS CO., LTD.	14
FWU YIH BRASS ENTERPRISE CO., LTD.	64	HWANG YU AUTOMOBILE PARTS CO., LTD.	15
GENERAL ACCESSORIES CORP.	28	HWANG YU AUTOMOBILE PARTS CO., LTD.	84
GENPLUS AUTO PARTS CO., LTD.	150	HWANG YU AUTOMOBILE PARTS CO., LTD.	85

Index

INAPA 2018	205	LUH DAH BRAKE CORPORATION	109
JIN BAO YUH INDUSTRY CO., LTD.	55	LUNG MING LI CO., LTD.	110
JIU ZHOU AUTOMOBILE PARTS CO., LTD.	33	MAIN HORN INDUSTRIAL CO., LTD.	118
JIUH CHING INDUSTRIES CO., LTD.	17	MATSUYAMA CO., LTD.	38
JOY TIME INDUSTRIAL CO., LTD.	50	MEGGIS ENTERPRISE CO., LTD.	74
JOYKU CORPORATION	34	MIDOLITECH CO., LTD.	158
JOYWELL MOTOR CORPORATION	79	MIIN LUEN MANUFACTURE CO., LTD.	39
JPS AUTO PARTS HK LTD.	35	MIMS AUTOMECHANIKA MOSCOW	206
JUIN DAW ENTERPRISE CO., LTD.	117	MOBALAGREEN ELECTRIC CO., LTD.	40
JUN-EN ENTERPRISE CORP.	201	MULTIVICTOR TECHNOLOGY CO., LTD.	75
KAE DIH ENTERPRISE CO., LTD.	189	NAKAMOTO INDUSTRIAL CO.	41
KAI GIU ENTERPRISE CO., LTD.	36	NAN SHUN SPRING CO., LTD.	103
KAI SUH SUH ENTERPRISE CO., LTD.	166	NAN SHUN SPRING CO., LTD.	172
KDC AUTO INDUSTRY CO., LTD.	125	NINE+PARTNERS INTERNATIONAL LIMITED	42
KELAI ENTERPRISE CO., LTD.	137	ORIENTAL STAR CHEMICAL INC.	90
KING ROOF INDUSTRIAL CO., LTD.	157	PAN ASIA AUTOPARTS LIMITED	111
KUAN KUNG MACHINERY CORP.	37	SAJONES CO., LTD.	112
L & S (TAIWAN) ALLIED CO., LTD.	73	SANE JEN INDUSTRIAL CO., LTD.	202
LI FONG TOOL CO., LTD.	190	SDING YUH INDUSTRY CO., LTD.	43
LIH DAH BRAKE LINING IND. CO., LTD.	107	SHANG HAO PRECISION TECHNOLOGY CO., LTD.	96
LINESOON INDUSTRIAL CO., LTD.	88	SHANG HAO PRECISION TECHNOLOGY CO., LTD.	104
LINESOON INDUSTRIAL CO., LTD.	94	SHEN MENG TRAFFIC EQUIPMENT CO., LTD.	66
LUCRE STAR INDUSTRY CO., LTD.	58	SIGMA AUTOPARTS CO., LTD.	67
LUH DAH BRAKE CORPORATION	108	SINDACO AUTOMOTIVE INDUSTRY CO., LTD.	113

Index

SING YUNG MACHINERY CO., LTD.	114	VIEW MAX INDUSTRIAL CO., LTD.	143
SLOOP SPARE PARTS MFG. CO., LTD.	86	WEI LIANG POWER WINDOW ENTERPRISE CO., LTD.	147
SONG YERS INDUSTRIAL CO., LTD.	179	WEI LIANG POWER WINDOW ENTERPRISE CO., LTD.	148
SSI EXHAUST INDUSTRIAL CO., LTD.	60	WELLTRON ELECTRONICS CO., LTD.	161
SUCCESS PRECISE CO., LTD.	18	WILLIAM TOOLS CO., LTD.	192
SUPERMAN MOTOR INDUSTRIAL LTD.	44	WILLIAM TOOLS CO., LTD.	193
TAI TSUN CO., LTD.	159	YANG SAN ENTERPRISE CO., LTD.	69
TAIPEI AMPA 2018	207	YANG SING PRECISION CO., LTD.	77
TAIR-WANG ENTERPRISE CO., LTD.	151	YEE-SHIN BEARING CO., LTD.	47
TAIR-WANG ENTERPRISE CO., LTD.	160	YEEU CHANG ENTERPRISE CO., LTD.	162
TAIWAN BRAKE TECHNOLOGY CORP.	115	YIH FENG INDUSTRIAL CO., LTD.	174
TAN KONG PRECISION TECH CO., LTD.	173	YING PAIO ENTERPRISE CO., LTD.	194
TESOR PLUS CORP.	146	YOKOMA AUTO CO., LTD.	48
TIEN YEH ENTERPRISE CO., LTD.	76	YONG SHENG CO., LTD.	144
TJB BEARINGS INC.	45	YOUNG SHINE ELECTRIC CO., LTD.	70
TKS INDUSTRIAL CO.,LTD.	141	YU CHUNG CHI ENTERPRISE CO., LTD.	131
TOOLS & HARDWARE INDONESIA 2017	208	YU CHUNG CHI ENTERPRISE CO., LTD.	139
TSAI HSING FA CO., LTD.	191	YUN SHUOH ENTERPRISE CO., LTD.	175
TSAN HSIN IND. CO., LTD.	68	YUNGYUAN FORWARD CO., LTD.	167
TZY KING ENTERPRISE CO., LTD.	142	ZHENG YUE ENTERPRISE CO., LTD.	163
TZYH RU SHYNG AUTOMATION CO., LTD.	198	ZUNG SUNG ENTERPRISE CO., LTD.	195
TZYH RU SHYNG AUTOMATION CO., LTD.	203	AUTOMECHANIKA MIDDLE EAST 2018	209
UNIQUE LITE INDUSTRY CO., LTD.	138		
V-TECH AUTO PARTS INDUSTRY CORPORATION	46		

Contents

■ Engine Parts	19
■ Engine Fittings	49
■ Exhaust System Parts	57
■ Cooling System Parts	61
■ Electrical Parts	71
■ Air-Conditioning Systems	78
■ Steering System Parts	80
■ Transmission System Parts	87
■ Suspension System Parts	97
■ Brake System Parts	105

Contents

■ Chassis Parts	116
■ Body Parts	119
■ Wheels, Tires, Wheel Covers	126
■ Lamps	128
■ Mirrors	140
■ Security Systems, Power Windows, Electronic Central Locks	145
■ Auto Accessories	149
■ Plastic & Rubber Parts	164
■ Metal Forming & Processing	168
■ Motorcycles	176

Contents

■ Special-Purpose Vehicles, Parts & Accessories	178
■ Repair Tool Kits & Equipment	180
■ Manufacturing Equipment & Others	196
■ Exhibitions	204



Guidebook to Taiwan Transportation Equipment Guide (TTG)

2017-09 Edition

TTG literally contains Taiwan's best suppliers of auto parts and accessories. If you're looking for well-made, competitively priced cast and forged parts, brakes and components, auto body parts, electrical parts, and repair tools etc., you can't go wrong with TTG. Multinationals and SMEs have relied on this buyer guide for years. 2 Issues per year (Apr, Sept.)

Index of Selected Suppliers

- Special Pages
- Engine Parts
- Engine Fittings
- Cooling System Parts
- Electrical Parts
- Air-Conditioning Systems
- Steering System Parts
- Transmission System Parts
- Suspension System Parts
- Brake System Parts
- Chassis Parts
- Body Parts
- Wheels, Tires, Wheel Covers
- Lamps
- Mirrors
- Security Systems, Power Windows, Electronic Central Locks
- Auto Accessories
- Plastic & Rubber Parts
- Metal Forming & Processing
- Motorcycles
- Special-Purpose Vehicles, Parts & Accessories
- Repair Tool Kits & Equipment
- Manufacturing Equipment & Others



TAITRA Hosts Seminars in Malaysia, Thailand and Philippines as Warm-up for Upcoming TAIPEI AMPA 2017

Trade fair is to represent thorough supply chain of Taiwan's auto-parts industry

By STEVE CHUANG

According to the data by the Industrial Technology Research Institute (ITRI) and the Taiwan Transportation Vehicle Manufacturers Association (TTVMA), the production value of Taiwan's automobile parts and accessories industry reached USD 7.342 billion in 2015, with around 2,510 manufacturers, including 410 OEM suppliers, tier-2 and tier-3 satellite factories operating under the Taiwan's 10 automakers, as well as 2,100 parts and accessories factories catering to the after-sales maintenance system.

Most of Taiwanese auto-parts makers are small and medium-sized enterprises (SMEs) which have developed a tightly wound central satellite factory system as well as advantageous customized service featuring flexible manufacturing at small quantity with high diversity. In addition, Taiwanese companies are highly competitive in terms of innovation, craftsmanship and pricing. Therefore, they also play very important roles in the global tuning parts and accessories market.

Exports account for 90% of the total production value of Taiwan's automobile parts and accessories industry. According to the statistics by TTVMA, Thailand, the Philippines and Malaysia are the largest, second-largest and fourth-largest markets respectively for Taiwan among ASEAN nations. Exports to these nations reached USD 110 million, 62.5 million and 58.5 million respectively in 2015. Compared with the same period in 2015, Taiwan's exports to Thailand dropped 10% to USD 82.7 million between January and October in 2016. However, exports to Malaysia increased 6.6% to USD 54.5 million, while exports to the Philippines surged 27% to USD 61.1 million.

Taiwan has a complete supply chain for the information & communication industries. Over the past 10 years, companies have, one after another, worked on system integration, such as in the domain of Advanced Driver Assistance Systems (ADAS). Semiconductor and IC design powerhouses in the upstream are beginning to vie

for the business opportunities associated with the Internet of Vehicles (IoV). According to the statistics by Automotive Research & Testing Center (ARTC), the production value of Taiwan's automobile electronic industry reached USD 5.5 billion in 2015, with great development potential in domains for enhancing driving safety such as tire pressure detection, heads-up display (HUD), lane departure warning, LED lighting, collision warning, fatigue detection and IoV. The industry supplies the global market in the forms of OEM, OES and AM, and some vendors are in partnership with Japanese car makers.

Taiwan's outstanding industrial performances have also triggered growth in exhibitions for related sectors. The TAIPEI AMPA and AutoTronics Taipei 2017 will take place between April 19 (Wed.) and 22 (Sat.), as 1,110 participating exhibitors from 15 countries expect to draw 6,700 foreign buyers and 22,000 vendors from Taiwan. Benchmark companies in Taiwan such as TONG YANG, DEPO, E-LEAD and MOBILETRON will be at the shows. For a long time, Japan has been the largest buyer at TAIPEI AMPA and AutoTronics Taipei. It is widely known that Japanese buyers have the most stringent demand for quality, and their patronage to the shows highlights the fact that both shows have received international recognition in terms of scale, available items on display, and exhibition-related services. On the other hand, visitors from ASEAN countries become a larger group. In 2016, nearly 400 Malaysian and 250 Thai buyers visited the shows, while the number of Philippine visitors grew 42% to 220; Malaysia, Thailand and the Philippines were the fourth-largest, eighth-largest and ninth-largest visitors, respectively.



Foreign visitors paid a visit to TAIPEI AMPA 2016(photo courtesy of TAITRA).



E-vehicles utilizing IoV was one of the highlights of AutoTronics Taipei(photo courtesy of TAITRA).

The MOTORCYCLE TAIWAN and EV TAIWAN are also set to take place concurrently. These four exhibitions arguably provide the most professional show platform for the two-wheel and four-wheel vehicle industries in Asia. For detailed information, please visit the exhibition website at <http://www.taipeiampa.com.tw>. Foreign visitors are welcome to register your visit in advance in order to take advantage of perks such as free airport pickup service.

In light of the significance of the Southeast Asian market to Taiwan's automobile parts and accessories industry, TAITRA is slated to hold the seminars - "Taiwan's Auto Parts Industry and Related Trade Shows" at Kuala Lumpur, Bangkok and Manila on Feb. 20, 22 and 24, respectively, covering issues ranging from Taiwan's automobile parts and accessories, automotive electronics, motorcycles parts and accessories, as well as the current status of Taiwan's electric vehicles. For related information, please contact Taiwan Trade Center in your country:

- TAIWAN TRADE CENTER, KUALA LUMPUR
Tel : +60-3-2031-2388 Fax : +60-3-2034-1388
Email: kl@taitra.org.tw
- TAIWAN TRADE CENTER, BANGKOK
Tel : +66-2-6514470 Fax : +66-2-6515923
Email: bangkok@taitra.org.tw
- TAIWAN TRADE CENTER, MANILA
Tel : +63-2-5517349 Fax : +63-2-5516827
Email: inquiry.manilattc@gmail.com

CENS



Tuningrims were among some of the important exhibit items at TAIPEI AMPA(photo courtesy of TAITRA).

Honesty Efficiency Professionalism

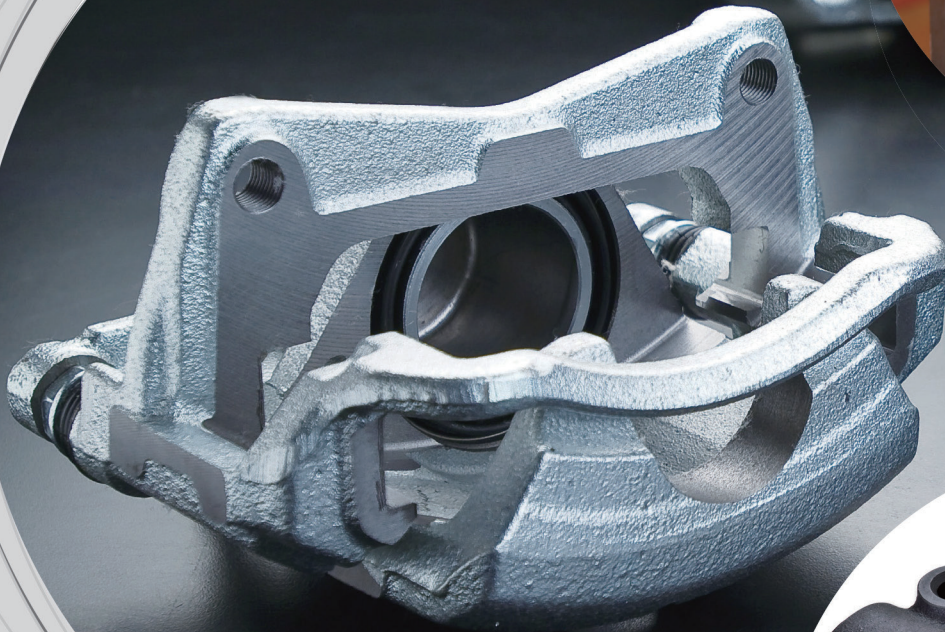



ISO 9001
ISO 14001
TS 16949



HWANG YU
AUTOMOBILE PARTS CO., LTD.

www.hwangyu.com



BAOCHENG ENTERPRISE CO., LTD.

Metal Forming, Motorcycle Pars, Motorcycle Accessories, Central Power Locks, Alarm Systems, Anti-Theft Devices, Steering Wheel

Ever since 1989, BAOCHENG ENTERPRISE CO., LTD., formally known Sincere Metal Ent. Co., Ltd., has been dedicated to "Metal Forming, Motorcycle Parts, Motorcycle Accessories, Central Power Locks, Alarm Systems, Anti-Theft Devices, Steering Wheel Locks, Gear Locks, Other Interior Accessories, Other Locks, Spare Tire Locks, Gear Shift Locks, Cylinder Locks, Cane Lock, Car Door Locks, Spare Tyre Locks, Bicycle Locks, Car Four-wheel Locks, Motorcycle Locks, Gear-shift Locks, Brass Bicycle Locks, Side Key Gear Shift Locks, Pressing-type Four Hooks, Theft-proof Steering Wheel Locks, Bat Steering Wheel Locks, Motorcycle Card Locks, Motorcycle Security Locks, Top Key Gear-shift Locks, and plastic, zinc alloy mould, aluminum mould development and manufacturing" with operati ...

BAOCHENG ENTERPRISE CO., LTD.

No.2, Ln. 4-30, Quanzhou Rd., Houli Dist., Taichung City , Taiwan 42142

Tel:04-25588700

Fax:04-25588701

E-mail: tw.baocheng@gmail.com

Website: www.fantaweb.com.tw



Three-Door Car Door Lock



Three-Door Car Door Lock



Cam lock



Cylinder Lock



CNC Complex Form Tuned & Ground Parts

JIUH CHING INDUSTRIES CO., LTD.

Tel:886-6-253-5459, 254-0830
Fax:886-6-253-0804
E-mail: juchin7880@gmail.com
Website: www.jiuhching.com

We are remarkable in producing special screws, nuts, sanitary utensils, electronic parts, auto/motorcycle spare parts and locks. Equipments: CNC/NC machine center, CNCF machine center, composite 65 mode of lathe, automatic eccentric lathe and automatic loose-cut lathe.



CNC Complex Form Tuned & Ground Parts



CNC Complex Form Tuned & Ground Parts



CNC Complex Form Tuned & Ground Parts

SUCCESS PRECISE CO., LTD.

ETA, Movement, Accessories Autos, Accessories Motorcycles, CDI, Dashboards, Electric Parts, Success, Prince, Hot

Success Precise Co., Ltd. was founded in 1981, main business includes the design, development, and production of various instruments, fuel sender and electronic components for the automobile, motorcycle, and marines. As this industry is experiencing a technological revolution, we continuously work with product leaders in Europe, United States and Japan to bring forth the newest technology, most modern design and the best management. At the same time we are keeping our competitive edge by investing in modern factories equipments both domestically and overseas and training a productive and professional force to run the operations. During these many years of business, our employees, customers, vender and the banks has continuously supported ...



Mechanical Instrument



Electronic Instrument



Mechanical Instrument



Electronic Instrument



SUCCESS PRECISE CO., LTD.

4th Fl., No. 76, Paokao Rd., Hsintien Dist., New Taipei City, Taiwan 231

Tel:886-2-2918-0566, 886-4-823-9188

Fax:886-2-2912-8514, 886-4-823-9187

E-mail: intspc@seed.net.tw

Website: www.s-p-c.com.tw



Engine Parts

FUJITECH MOTOR PARTS CO LTD.	21
AURORAL SINTER METALS CO., LTD.	22
CHIN CHIH METAL INDUSTRIAL CO., LTD.	23
CHUAN JIEEN ENTERPRISE CO., LTD.	24
DEMAX ENTERPRISE CO., LTD.	25
DITERNA AUTO PARTS CO., LTD.	26
FAIR SUN INDUSTRIAL CO., LTD.	27
GENERAL ACCESSORIES CORP.	28
GOLDEN WARE INT'L INC.	29
GRAND FORGING INDUSTRIES CO., LTD.	30
HOLI INDUSTRY CO., LTD.	31
HSIANG LUN INTERNATIONAL CORP.	32
JIU ZHOU AUTOMOBILE PARTS CO., LTD.	33
JOYKU CORPORATION	34
JPS AUTO PARTS HK LTD.	35
KAI GIU ENTERPRISE CO., LTD.	36
KUAN KUNG MACHINERY CORP.	37
MATSUYAMA CO., LTD.	38
MIIN LUEN MANUFACTURE CO., LTD.	39
MOBALAGREEN ELECTRIC CO., LTD.	40
NAKAMOTO INDUSTRIAL CO.	41
NINE+PARTNERS INTERNATIONAL LIMITED	42
SDING YUH INDUSTRY CO., LTD.	43
SUPERMAN MOTOR INDUSTRIAL LTD.	44

TJB BEARINGS INC.	45
V-TECH AUTO PARTS INDUSTRY CORPORATION	46
YEE-SHIN BEARING CO., LTD.	47
YOKOMA AUTO CO., LTD.	48

FUJITECH MOTOR PARTS CO LTD.

We are Group Company which have our own Filter factory in China & export since 1993 to over hundreds of countries in the world. In our Auto Parts Trading section, we own one team of professional and long experience engineer whom will secure you getting high quality Auto Parts with competitive price. In section A Division, we export high quality O.E & ISO16949 certificate factory from Asia Country as China, Taiwan & Japan. In section B Division, export 100% genuine parts (Japanese, Korean & European vehicle & truck) & also Japan original bearing & oil seal.



MADE IN CHINA - REPLACEMENT / OE

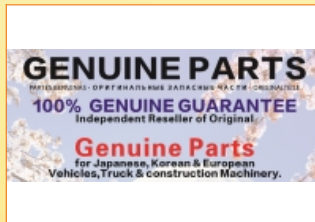

GENUINE PARTS SPECIALIST



TRUCK&MACHINERY



OIL FILTER (FILTER FACTORY)



FUJITECH MOTOR PARTS CO LTD.

P O BOX 80671 ,CHEUNG SHA WAN POST OFFICE , HONG KONG

Tel:852-2728-7529

Fax:852-2887-8042

E-mail: exp@fujitech-motorparts.com.hk

Website: www. fujitech-motorparts.com

AURORAL SINTER METALS CO., LTD.

Powder Metallurgy

Auroral, which is located in Zaociao town, Miao county in Taiwan, is a professional manufacturer of powder metallurgy since 1996. Auroral always adheres to the motto "Sincere management, best service, superior quality in the field of the powder metallurgy. We also pursue the spirit of innovation and creation by update modern equipments. All the efforts we make is for promoting competition. Our perspectives focus on internationalized and diversified development. We provide automobile parts, pump gears, rotors and so on. Auroral can grows steadily due to customer's support and affirmation. Furthermore, employees are viewed as the most valuable assets. We have the faith that self-improving and skill-sharpening will lead us to establish the s ...



AURORAL SINTER METALS CO., LTD.

No.10, Dongxing, Lin 13, Zaociao Village, Zaociao Township, Miaoli County, Taiwan 36141

Tel:886-37-542-988

Fax:886-37-541-656

E-mail: am@auroral-sinter.com.tw

Website: www.cens.com/auroral



Inner and Outer Rotor



Synchronizer



Transmission Parts



Gears

CHIN CHIH METAL INDUSTRIAL CO., LTD.

Gear, Timing Gear, abs Sensor Ring, Oil Impregnated Bearing, Rotor, Starter Bushing, Compressor Parts

Area site: 9,920 sq. meters Buildings: 6,610 sq. meters Capital: NT\$80 million Revenue: US\$7.5 millions (1998) Outline 1980: Established at Sanyi Miaoli, Taiwan 1980: Started to produce oil impregnated bearings 1984: Commenced the production of mechinvery parts 1987: Factory was expanded 750-ton forming presses used 1991: Trademark registered 1994: ISO-9002 certified; began to utilize four sintering furnaces imported from Germany 1995: Commenced the 500 and 200-ton forming presses 1996: New head-office constructed; 600-ton sizing machine was added to our production line. 1999: 200kg Sintering Furnace Started, 100, 50, 40, 20 Tons Copacting Presses Started Heat Treatment Furnace Started



Timing gears



Timing gears



Hub / Nut



Electric - powered/ air tool parts



CHIN CHIH METAL INDUSTRIAL CO., LTD.

51 Baku Rd., Sanyi Township, Miaoli County, Taiwan 367

Tel:886-37-872-136

Fax:886-37-873-936

E-mail: ccmc@chinchih.com

Website: www.chinchih.com



Solenoid Valves-Refrigerant Solenoid Valves

CHUAN JIEEN ENTERPRISE CO., LTD.

Tel:886-6-262-4080
 Fax:886-6-262-4184
 E-mail: sales1@chuanjjeen.com.tw
 Website: www.chuanjjeen.com.tw

Chuan Jieen Enterprise Co., Ltd. , founded in 1987 , is a specialized manufacturer in a wide range of products, including Fast Idling Control Device, Actuator, Vacuum Solenoid Valve, One-Way Valve, T Pipe, Hose, Auto Air-Conditioner parts such as Hose Fitting, Aluminum Pipe and Blower, etc. We have great competitive advantages in terms of product design, price, timely delivery and high Qu ...



PV-063

Solenoid Valves-Exhaust Gas Recirculation Control Solenoid



PV-076

Solenoid Valves-Canister Purge Solenoid



PV-085(12V)

Controls the flow of water

Heater Valves

DEMAX ENTERPRISE CO., LTD.

**Engine Parts, Electrical Parts,
Steering System, Rubber Parts**

Professional Auto Parts Manufacturer OEM / ODM
Orders Are Welcom



Engine Systems



Engine Systems



Plastic Parts

DEMAX ENTERPRISE CO., LTD.

1st Fl., No. 151-5, Minsheng E. Rd., Sec. 5, Taipei City,
Taiwan 105

Tel:886-2-2747-9099

Fax:886-2-2747-9097

E-mail: demax@seed.net.tw

Website: www.cens.com/demax



Plastic Parts

DITERNA AUTO PARTS CO., LTD.

Engine Mount, Arm Bush, Strut Mount, Air Intake Hose, Stabilizer Bush, Rubber Parts

Established in 1990 in Hsinchu County, Taiwan, Diterna Auto Parts Co., Ltd. is a locally renowned maker of automotive chassis and suspension parts, who started to export globally backed by its own international sales team set up in 2013 rather than via traders as it did originally. Offering some 1,000 kinds of products, we are aware of mainstream trends to turn out products that are guaranteed marketable, enabling customers to achieve sales easily. With automotive parts manufacturers in fierce competition in recent years, product quality is no longer guaranteed since some makers might reduce cost to lower price, but we still invest sizably in R&D to uphold quality, a strategy for success that has shown effective amid cut-throat rivalry. Turning out auto rubber parts with ED (electrophoretic deposition) coating rather than conventional surface painting, ...

DITERNA AUTO PARTS CO., LTD.

No. 66, Lane 1282, Zhongzheng W. Rd., Zhubei City, Hsinchu County, Taiwan 302

Tel:886-3-556-8111

Fax:886-3-556-8000

E-mail: sales@diterna.com.tw

Website: www.cens.com/diterna



Stabilizer Bush



Air Intake Hose



Strut Mount



Strut Mount

FAIR SUN INDUSTRIAL CO., LTD.

Electrical Parts, Resistor Units, Starter Solenoids

Fair Sun Industrial Co., Ltd was founded in Taiwan in 1980, and our subsidiary in Shanghai appeared in 1999 with a goal to achieve market integration and technological consolidation. Today, Fair Sun has expanded its technological capacity to provide its worldwide customers with the highest quality services that demonstrate our professionalism, confidentiality, reliability and integrity. Fair Sun is involved in manufacturing Turn Signal Switches, Headlight Switches, Ignition Switches, Lock Cylinders, Voltage Regulators, Starter Solenoids, and other electrical auto parts that cover various car brands. We strive to achieve excellence with all our products and operation procedures while following our guidelines: First In Cust ...

FAIR SUN INDUSTRIAL CO., LTD.

1st Fl., No. 62, Beining Rd., Taipei, Taiwan 105

Tel:886-2-2570-0236, 2570-0217

Fax:886-2-2570-0317, 2570-0327

E-mail: fairsun@seed.net.tw

Website: www.fairsun.com



MECHANICAL STOPLIGHT SWITCHES



SOLENOIDS



TURN SIGNAL SWITCHES



Dimmer Switches

GENERAL ACCESSORIES CORP.

Auto Spare Parts, Motorcycle Spare Parts, Engine Parts, Chassis Parts, Suspension Parts, and Electrical Parts

Since 1974, GENERAL ACCESSORIES CORP has specialized in the exporting of AUTO/MOTORCYCLE parts and ACCESSORIES as well as MOTORCYCLE complete set for over 40 years. We have exported to over 40 countries in Mideast Asia, Central and South America, North America, Europe, and Africa. As established international trader of values trust and reputation, General Accessories Corp. places its priorities on good customer service. We deliver high quality goods promptly. We have our own inspection team which oversees suppliers' production, examines finished products, and supervises packing and shipping. As a result AUTO/MOTORCYCLE parts, ACCESSORIES, and MOTORCYCLE complete set delivered to customers are ensured the highest quality. We maintain cordial relations with par ...



AUTO PARTS



BALL JOINT

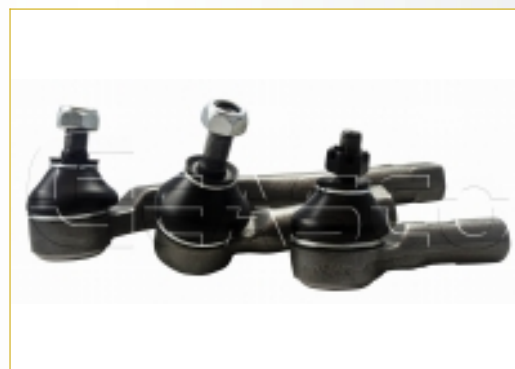

TIE ROD END



FUEL PUMP



GENERAL ACCESSORIES CORP.

9th Fl., 57 Fuhsin N. Rd., Taipei, Taiwan 105

Tel:886-2-2752-8327

Fax:886-2-2731-5517

E-mail: info@geasco.com.tw

Website: www.geasco.com.tw

GOLDEN WARE INT'L INC.

Aluminum Door Handles, Flush Bolt, Finger Catch, Sliding Latch & Pull Handle, Hinge, 4 Bar Hinge, Cam Handle, Sliding & Patio Handle, Window Roller, Screw, Screw Driver, Blind Rivet, Riveter, Cylinder Lock

Golden Ware Int'l Inc. are Taiwanese company, we have providing building hardware, industry, Auto & Air Plane parts from Taiwan & China since 1990, All OEM parts made by investment casting, Alum. Extrusion, CNC machining, stamping, die casting, alum. extrusion...etc. by material of S.S., Alum. Zinc, Nylon with inspection equipment of Chemical Analysis, CMM, Pressure, Hardness, Tensile and Impact Testing, for the market of France, Germany, U.K., Slovakia, Poland, Canada, USA, Saudi Arabia, Yemen, Tanzania, Hong Kong, Singapore, Australia & New Zealand. Much welcome you send us your inquiry of 2D or 3D or sample to us for quote a reasonable price for your reference, for sure we will be the best supplier for you.



STAINLESS STEEL COUPLING

GOLDEN WARE INT'L INC.

11th Fl., No. 12, Lane 298, Hsinming Rd., Neihu Dist., Taipei, Taiwan 114

Tel:886-2-2793-7889

Fax:886-2-2793-7891

E-mail: goldenware@goldenware.com.tw

Website: www.goldenware.com.tw

GRAND FORGING INDUSTRIES CO., LTD.

Forging Hand Tool Components & Parts, Cold Forging, Cold Forming, Forged and Cast Parts, Auto Repair Tools, Hand tool Parts

Established in December 1989 at No. 533, Tzuli 2nd St., Wuchi Town, Taichung County, Taiwan (Kuan Lien Industrial Area), we handle metal forgings and adhere to ISO9001:2000 QC standards to enhance competitiveness and product quality. Continually upgrading corporate efficiencies is key to sustainable business. Featuring four 650-ton forging facilities with progressive dies for fully automated production, we became ISO9001:2000 certified in August 2004. We supply forgings; and manufacture and process parts for autos/motorcycles, machinery, bicycles, hardware items, and tools. In recent years, our main products are auto airbag parts. We prioritize product quality and on-time delivery, enabling customers to fully trust us. Production facilities: Forging machine tools: Toggle-type punch press KP-1200 (Chin Fong) 3 Unit Toggle-type punch ...



GRAND FORGING INDUSTRIES CO., LTD.

553 Zili 2nd St., Wuqi Dist., Taichung City, Taiwan 435

Tel:886-4-2639-3866

Fax:886-4-2639-3869

E-mail: grandfor@ms59.hinet.net

Website: www.grandforging.com



Hand Tool Components & Parts



Auto Components & Parts 05



Aluminum Alloy and Brass Forgings



Other Hardware Parts 01

HOLI INDUSTRY CO., LTD.

M-Benz W/210 Body Moulding, Body Parts, Auto Accessories

As we are a manufacture and exporter for automotive body parts since 1987, and specialized in the range of "Mercedes Benz" & "BMW." We have professional experience in this line and good reputation for our service & quality.



F.BUMPER STRIP LH,
W/CHROME MOULDING,



F.BUMPER STRIP RH,
W/CHROME MOULDING,

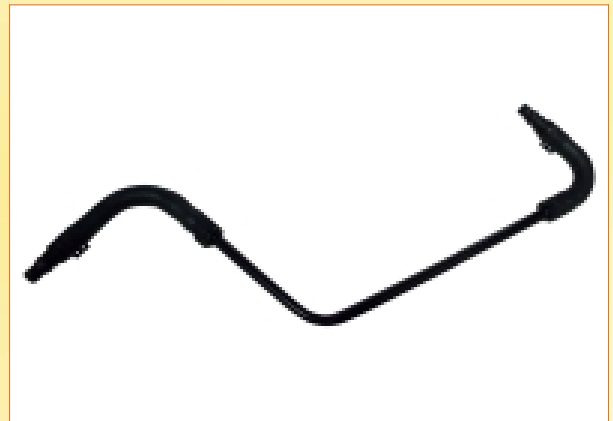

BREATHER PIPE M271 -11



BREATHER PIPE CGI

HOLI

HOLI INDUSTRY CO., LTD.

1F, No.15, Lane 198, Tehwei St. Taipei 10471, Taiwan.

Tel:886-2-2595-9877, 2591-2565

Fax:886-2-2595-1834

E-mail: n7169@ms64.hinet.net

Website: www.holi-auto.com

HSIANG LUN INTERNATIONAL CORP.

Engine Parts, Oil Seals, Overhaul Set, Cylinder Head Gaskets, Rubber Parts, Metal Forming & Processing, Gasket

Respect of the “environment” and adherence to “quality”, HLIC/SanHo Industry Co. further extends its efforts. Founded in 1969, HLIC/SanHo Industry Co. is an esteemed Asian manufacturer specializing in the production of engine parts and components. For more than 30 years, we have dedicated ourselves to the research, development, design and production of engine sealing components. Today, we have attained the capability to produce all types of sealing products for a full range of engine applications. Major engine parts manufacturers and trading partners, both at home and abroad, positively affirm our distinguished quality control methods. Since our establishment, we have demanded the most rigorous management of production flow. W



METAL RUBBER / PLAS



METAL GASKET



ASBESTOS FREE HEAD GASKET

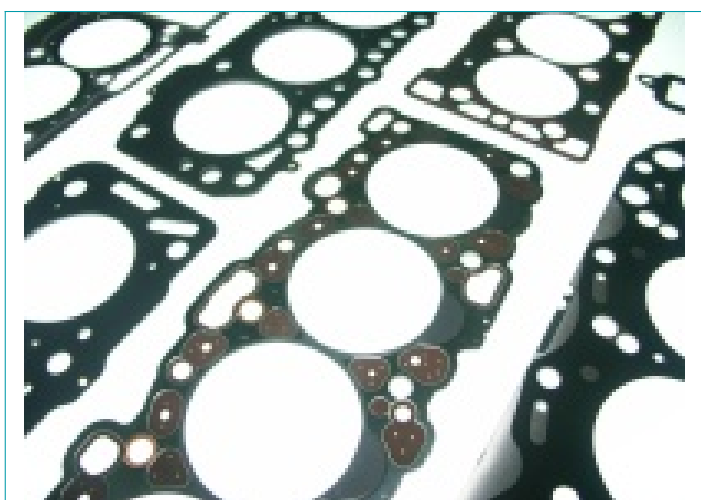

MLS HEAD GASKET

HSIANG LUN INTERNATIONAL CORP.

6th Fl., No. 106, Changan W. Rd., Taipei City, Taiwan 103

Tel:886-2-2552-2828

Fax:886-2-2559-3939

E-mail: autopart.sales@hlic.com.tw

Website: www.gaskets.com.tw

JIU ZHOU AUTOMOBILE PARTS CO., LTD.

Oil Pan Gasket, Valve Cover Gasket, Timing Cover Gasket, Rubber Kits

Founded in 1978, JIU ZHOU AUTOMOBILE PARTS CO., LTD has won great reputation with outstanding quality and wide range products supplies, such as lots of automobile brands of Oil Pan Gasket, Valve Cover Gasket, Timing Cover, and Rubber Kits. High quality, good service and reasonable price have been our aims to keep good relationships with our customers, so we have confidence to get your trust. JIU ZHOU AUTOMOBILE PARTS CO., LTD welcomes any new products; therefore, we love to cooperate with you on whatever any new products. At last, we sincerely hope you can give us an opportunity that will bring you everlasting benefits.



JIU ZHOU AUTOMOBILE PARTS CO., LTD.

No. 36, Lane 180, Xinhe Rd., Longtan Township, Taoyuan
County, Taiwan 32543

Tel: 886-2-2636-0558 Ext. 12

Fax: 886-2-2636-0978

E-mail: daisylee@jz-ld.com

Website: www.jz-ld.com



Rubber Kits

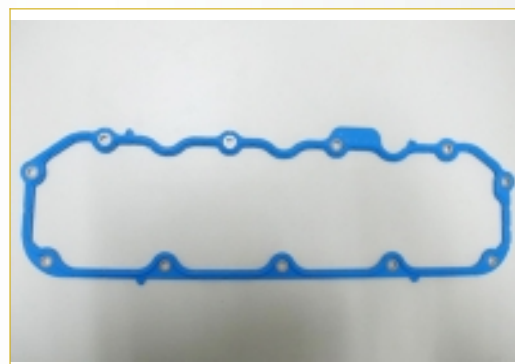

Side Cover Gasket

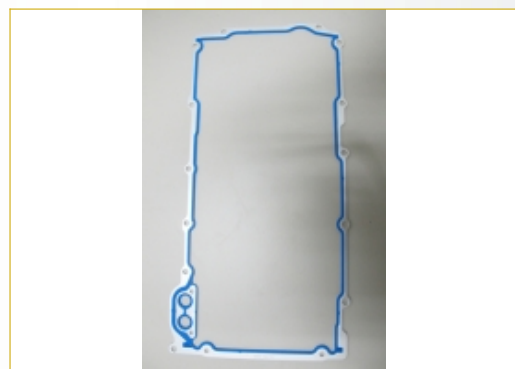

Oil Pan Gasket

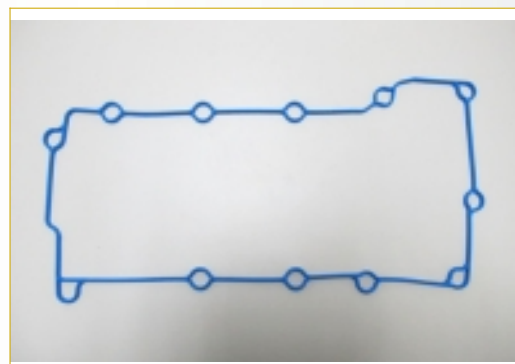

Valve Cover Gasket

JOYKU CORPORATION

Clutch Release Bearing, Timing Belt Tensioner, Idler Pulley, Collars, Ball Bearing for Generator

Exporter of Automotive Bearings, Automotive Spare Parts, Timing Belt Tensioners, Adjuster, Hydraulic Tensioners, Hydraulic, Idler Pulleys, Clutch Release Bearings, Wheel Bearings, Strut bearings for Shock Absorbers, Locking Collars for Wheel Bearings, Air Conditioning Ball Bearings, Generator Bearings



Timing Belt Tensioner



Timing Belt Tensioner



Timing Belt Tensioner



Timing Belt Tensioner

JOYKU CORPORATION

11th Fl.-2, No. 204, Minsheng E. Rd., Sec. 5, Songshan Dist., Taipei City, Taiwan 10589

Tel:886-2-2528-3385, 2748-6871

Fax:886-2-2528-1032, 2756-2947

E-mail: joyku@ms12.hinet.net

Website: www.hye.com.tw

GENUINE PARTS

PARTES GENUINAS · ОРИГИНАЛЬНЫЕ ЗАПАСНЫЕ ЧАСТИ · ORIGINALTEILE

100% GENUINE GUARANTEE

Independent Reseller of Original

Genuine Parts

for Japanese, Korean, European & American
Vehicles, Truck & construction Machinery.

We keep big inventory for fast moving items with prompt delivery.
We also accept indent order with special competitive price with short delivery time.



We also supply Replacement Parts from Japan origin

Note: 1) As according different country agency policy, supply of above brand subject final confirmation of the factory.
2) Above logo & brand is belong to each brand holder (factory) our print information is just for reference only.



JPS Auto Parts (HK) Limited

P.O. BOX 80725, Cheung Sha Wan Post Office, Kowloon, Hong Kong

Tel: (852) 2807 0359 Fax: (852) 2807 2583

Email: sales@jpsautoparts.com.hk Website: www.jpsautoparts.com.hk

KAI GIU ENTERPRISE CO., LTD.

Window Regulator, Door Lock, Center Lock, Door Handle, Cylinder Liner, Piston, Transmission Gear

Kai Giu Enterprise Co., Ltd. is a professional supplier and exporter in the automotive industry over 30 years. With accumulated product development experience, strict quality control systems, and comprehensive customer services, we have earned a solid reputation in the automotive parts and components field. Our company policy is to provide our customers with superior products, at competitive prices and with the fastest lead time. We specialize in engine parts, transmission parts (transmission gear, ring synchronizer), stabilizer link, rock end, oil seal and repair kits. Meanwhile, we also work with customers under exclusive-supply tooling projects. Continuous progress in quality and management enables us to satisfy all our customers' various needs. It would be our great pleasure to hear from you.



KAI GIU ENTERPRISE CO., LTD.

3rd Fl.-2, 490 Tachin St., Nantun Dist., Taichung, Taiwan 408

Tel:886-4-2329-2393

Fax:886-4-2329-2391

E-mail: kaigi@ms55.hinet.net

Website: www.marvel-auto.com.tw



Headlamp Connector Harnesses



Universal Connector Harnesses



Wire Harnesses



Thermo Switch

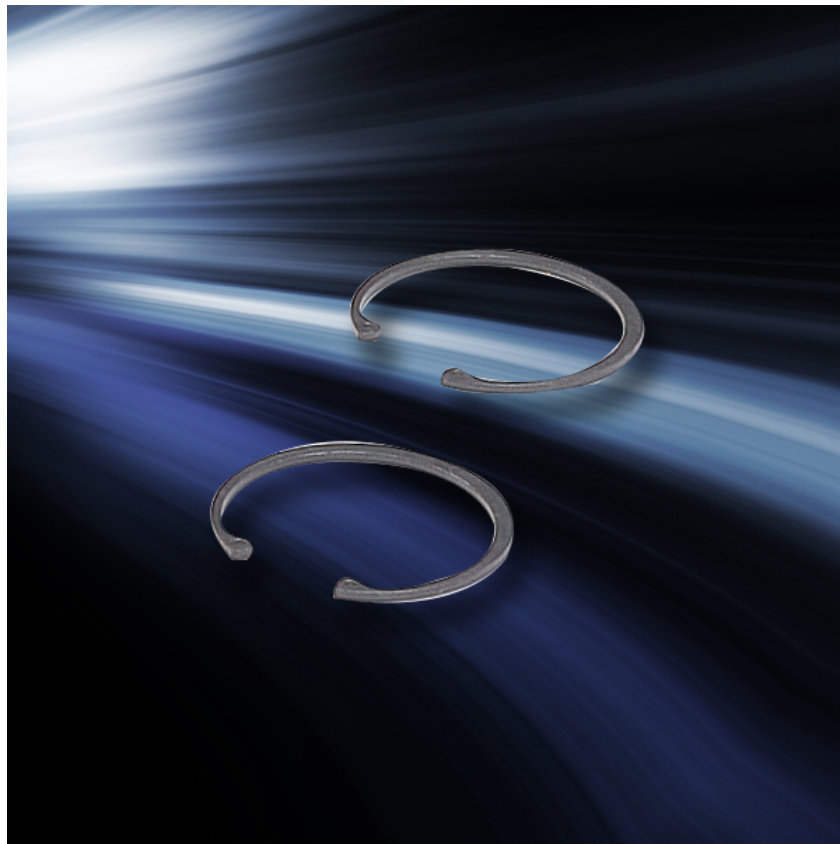

Piston Pin & clip

KUAN KUNG MACHINERY CORP.

Tel:886-4-2335-0037 (3 line)
Fax:886-4-2335-0036, 2335-5834
E-mail: kkmswang@gmail.com
Website: www.cens.com/kuan-kung

The New Factory was built for Liner Operations in 3 floors 2001. The total layout is very projected, neat, clean and efficient. Elevator and Fork Lift setup for moving Material between floors. Warehouse for Finished Goods is located another place very closed to this Main Factory. It also stocks Piston, Ring, Bush and Packing Materials. In it, an semi-auto machine for de-oil and anti-rusty oil ap ...

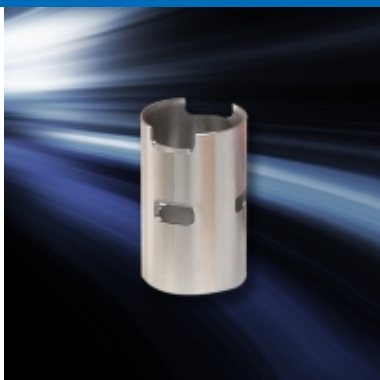

Cylinder Liners



Cylinder Liners



Cylinder Liners

MATSUYAMA CO., LTD.

Liner Kits, Liner Gasket, Overhaul Kits, Packings, Pistons, Liner

MATSUYAMA Co., Ltd., is a professional engine spare parts manufacturer and exporter for KOMATSU, CATERPILLAR, MITSUBISHI, TOYOTA, ISUZU, NISSAN, HINO and MAZDA in Taiwan. Based on more than 30 years experiences in developing and manufacturing engine spare parts, we can supply you the following quality-trusted engine spare parts, CYLINDER LINER KIT (including Piston Set, Cylinder Liners, Piston Ring Set, Piston Pins, Liner O-Ring, Clips and Bushings), PISTON KIT, IRON PISTON, PISTON RING, PISTON PIN, BUSHING, BEARING, LINER O-RING, OVERHAUL GASKET, HEAD GASKET, NOZZLE TUBE, OIL SEAL, INJECTOR ASSEMBLY. We are especially proud of offering wild-range of spar ...

MATSUYAMA CO., LTD.

No. 169, Lite St., Taichung City, Taiwan 401

Tel:886-4-2222-7766, 2283-2500

Fax:886-4-2283-2502

E-mail: matsuya@ms76.hinet.net

Website: m.cens.com/s/89983118



Head Set Gasket – Caterpillar 3406 K1



Mitsubishi Piston Ring – S6R2



Komatsu Piston Ring – S6D170



CATERPILLAR PISTON – 3512~3516

MIIN LUEN MANUFACTURE CO., LTD.

Wheel Hub, Bearing Assembly, Suspension Parts, Suspension Systems, Adjust Tensioner, Auto Tensioner

(T&T)(ML)Miin Luen Manufacture Co., Ltd. is the leading manufacturer in Taiwan, having specialized in front and rear wheel hub and bearing assemblies for the last 16 years. We currently export our products to the USA, Europe, Southeast Asia, Middle East, and China with the reputation of quality products and competitive prices. Miin Luen has been certified by ISO 9001:2008. Including over 2,000 kinds of auto parts , our products apply to the vehicles of TOYOTA, NISSAN, MITSUBISHI, HONDA, SUBARU, DAIHATSU, SUZUKI, ISUZU,G.M, FORD/MAZDA, CHRYSLER, B.M.W, VW., AUDI, OPEL, PEUGEOT, CITROEN, RENAULT, SAAB, FIAT, ALF ...

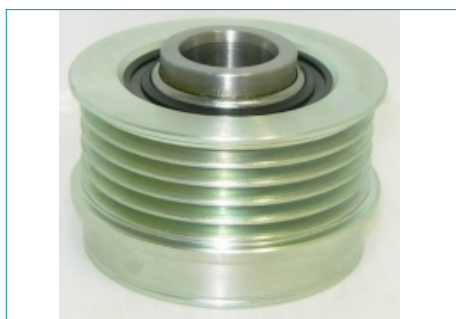

Overrunning Alternator Pulley



T&t(Safety and Stability) ,Mi



TOYOTA A/C BELT AUTO



Mitsubishi



MIIN LUEN MANUFACTURE CO., LTD.

10-1 Tian Hsin Tzi, Hsing Hua Vil., San Chi Dist., New Taipei City, Taiwan 25243

Tel:886-2-2637-2525

Fax:886-2-2637-2323

E-mail: htang.mlco@msa.hinet.net

Website: www.miinluen.com

MOBALAGREEN ELECTRIC CO., LTD.

Automobile & Motorcycle Wire Harness for HID, Sorket

Supplying wide-ranging connectors for cars, motorcycles and electronics, we also develop and process connectors and electrical wiring of special specs. Adhering to stringent production, we promote management based on prioritizing quality, customer service and technology transfer, hence creating mutual benefits for maximum profit.



MOBALAGREEN ELECTRIC CO., LTD.

1st Fl., No. 56, Lane 277, Yuanyuan Rd., Nuannuan Dist., Keelung City, Taiwan 205

Tel:886-2-2459-0747

Fax:886-2-2459-0717

E-mail: somy.tw@msa.hinet.net

Website: www.mbg.com.tw



Connectors



Connectors



Connectors



Connectors

NAKAMOTO INDUSTRIAL CO.

Air Flow Meter, Speedometer Sensor, PCV Valve, Camshaft Sensor, Magnetic Pickups Coils, Switches, Locks, Ignition Modules

NAKAMOTO INDUSTRIAL CO. is dedicated in Air Flow Meter, Speedometer Sensor, PCV Valve, Camshaft Sensor, Magnetic Pickups Coils, Switches, Locks, Ignition Modules Coil, Distributor Cable, Distributor, Cap, Rotor and Cable, Diesel Pumps, Transmission, Air, Fuel and Oil Filter, Water Pipe and Outlet, Manifold, Flying Wheel, Pulley and Casting, Forging Parts, Truck and Forklift Steering Parts, Cross, Side Rod and Tie Rod End, Control Arm, Stabilizer Bar and Rack End, Suspension Parts, Flange, York, Universal Joint and Shaft, Kunckle and Arm, Shock Absorber, Spring, Shock Absorber Mounting, Power Steering Rack Pinon Unit, Power Steering Pump, C.V. Joint and Steering Boot, Wheel Hubs-Abs Ring, Idler Pulley Bearing, Clutch Release Bearing, Center Bearing Cus ...

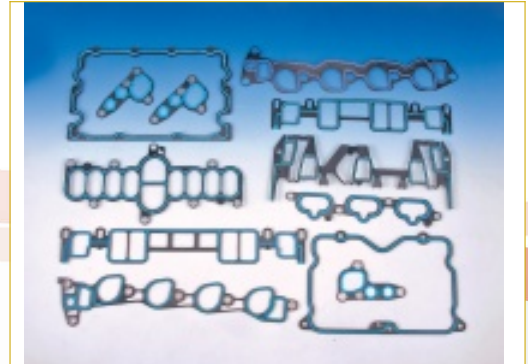

Engine Parts



Cross, Side Rod & Tie Rod End



valve cover, bushing & rubber parts



Brake Parts

NAKAMOTO INDUSTRIAL CO.

8th Fl., No. 20, Lane 478, Ruiguang Rd., Neihu Dist., Taipei, Taiwan 114

Tel: 886-2-2797-6777

Fax: 886-2-2797-2092

E-mail: autoparts@nakamoto.com.tw

Website: www.nakamoto.com.tw



www.hjlautoparts.com



NINE+PARTNERS INTERNATIONAL LIMITED

candy.lai@motowell.com.tw

SkypeID:imcandylai

No.19, Aly.56, Ln.615, Sec.2, Yanghu Rd., Yangmei District, Taoyuan City, Taiwan



Spedal®

Lohas In Action!

www.lohasdigital.com

Multi-function Portable Car Jump Starter
Support petrol & diesel vehicles
As a power bank for smart phones & tablets
High Power LED built-in



SDING YUH INDUSTRY CO., LTD.

Timing Kit, Timing Chian, Chain Guide, Chain Tensioner

We are a professional manufacturer specializing in timing kit, timing chain, chain guide and chain/ belt tensioner based in Taiwan. These entire ranges of products are quality fabricated and are exceptionally reliable. For those in search of the best timing kit for automotive engine applications, we are certainly your number one choice! We keep all the 1000 timing kit items, we produced in stock. Complete stock and speed delivery is our top mission of service.



SDING YUH INDUSTRY CO., LTD.

No. 16, Lane 331, Jungjeng N. Rd., Sanchong Dist., New Taipei City, Taiwan 241

Tel:886-2-8988-2128

Fax:886-2-8988-2532

E-mail: sdingyuh@sdingyuh.com.tw

Website: www.cens.com/sdingyuh



TIMING KITS,TK-TY206



TIMING KITS,TK-VW006



TIMING KITS,TK-TY194



TIMING KITS,TK-TY186

SUPERMAN MOTOR INDUSTRIAL LTD.

**Auto Parts and Accessories, Automobile Accessories,
Spare Parts, Lamps, Motor Equipments**



Auto Parts and Accessories

SUPERMAN MOTOR IND. Ltd. Is a leading and professional auto parts exporter in Taiwan. We are capable of supplying any parts available in Taiwan at competitive prices with full container loads, mixed containers, LCL shipment or air freight if the shipment is required urgently. With our successful and professional experiences for decades, we can be your best supplier in Taiwan.



Filters & Cooling Fans



Rubber & Plastic



Electric Parts

REPUS

SUPERMAN MOTOR INDUSTRIAL LTD.

6th Fl., 91 Nanking E. Rd., Sec. 3, Taipei, Taiwan 104

Tel:886-2-2506-9722

Fax:886-2-2506-1845

E-mail: carparts@ms10.hinet.net

Website: www.supermanmotor.com

TJB BEARINGS INC.

Engine Bearing, Pulley, Clutch Assembly, Rear Axle Assembly, Parts for Constant Velocity Joint Type Drive Shaft

TJB BEARINGS INC. is dedicated in Engine Bearing, Pulley, Clutch Assembly, Rear Axle Assembly, Parts for Constant Velocity Joint Type Drive Shaft, C.V. Joint (Automotive Part), Rear Wheel Transmission Shaft, Engine Clutch Release Bearings, Timing Belt Tensioner/Idler Pulley, Air-Condition, Automotive Bearings, Belt Tensioner Bearings, Idler Pulley Bearings, Wheels Bearings, Ball & Roller Bearings, Collar and ABS Rings with operations in Taiwan

TJB BEARINGS INC.

No.23-15, Sec. 2, Minyi Rd., Wugu Dist., New Taipei City 248, Taiwan

Tel:02-8292-1199

Fax:02-8292-1888

E-mail: tjbbrg@ms35.hinet.net

Website: www.tjb-bearings.com.tw

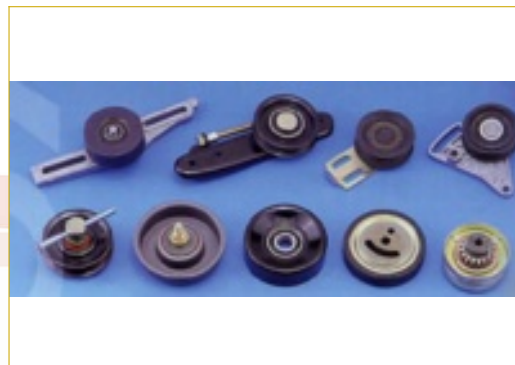

Air-Condition / Alternator / Drive Component

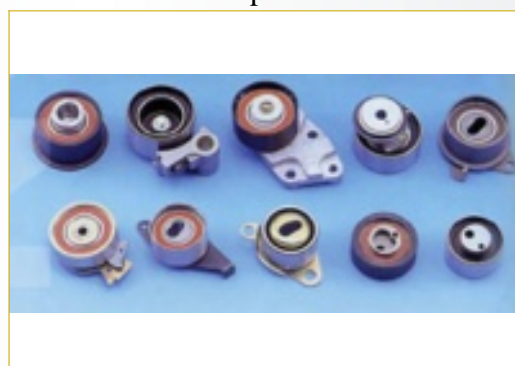

Timing Belt Tensioners / Idler Bearings

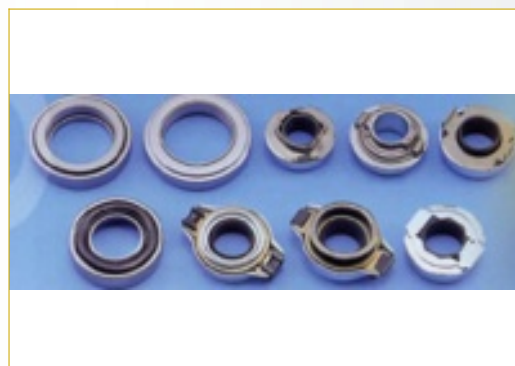

Engine Clutch Release Bearings



Front Wheel /Rear Wheel Bearings

V-TECH AUTO PARTS INDUSTRY CORPORATION

Engine Overhaul Gasket, Valve Cover Gasket, Oil Pan Gasket, Engine Repair Gasket Kit, Cylinder Head Gasket

V-TECH Auto Parts Industry Corporation is one of the main manufacturer and exporter of spare parts for KOMATSU- TOYOTA- NISSAN -MITSUBISHI -MAZDA-ISUZU-HINO. We are specialized in engine spare parts of automotive in Taiwan and we can supply you the following spare parts: ENGINE OVERHAUL GASKET, CYLINDER HEAD GASKET , VALVE COVER GASKET , OIL PAN GASKET , EXHAUST MANIFOLD GASKET , INTAKE MANIFOLD GASKET , LINER O-RING KITS , VALVE SEAL , NOZZLE TUBE , OIL SEAL.... Our business goal is to provide superior qualitative, excellent service and competitive prices to our client .We have an experience of 40 years on manufacturing and exporting spare parts all over the world. Our company policy is based on building good business relationship between supplier ...



Engine Overhaul Gasket Kits-WL



Engine Overhaul Gasket Kits-6D15



Engine Overhaul Gasket Kits-4HG1



Engine Overhaul Gasket Kits-VN



V-TECH AUTO PARTS INDUSTRY CORPORATION

No. 10, 56 Lane Zhongzheng Rd., Xinzhuang Dist., New Taipei City 24243

Tel:886-2-2279-1312

Fax:886-2-2279-1355

E-mail: vtech123@ms72.hinet.net

Website: www.cens.com/v-tech

YEE-SHIN BEARING CO., LTD.

Clutch Release Bearing, Automotive Bearing Specialist, Timing Belt Tensioner, Idler Pulley, Collars, Ball Bearing for Generator

Set up in 1990, we design and make automotive clutch release bearings, belt tensioner bearings, A/C idler pulley bearings etc., which are amply stocked year round. Despite fierce competition globally, we keep sharpening technological edge to supply quality but cost-effective products to build high regard among long-term partners in Europe, North, South-Americas and the Mid-east. We supply belt tensioner bearings, clutch release bearings, belt and idler pulleys, wheel bearings, hubs and special bearings, timing belt tensioners, crank pulleys, locking collars, A/C alternator bearings etc. for American Ford, Crown Victoria, Town Car, Grand Marquis, GMC, Chevy, C-10, Suburban, Malibu, Jimmy, Caprice, Blazer etc. as well as Mercedes-Benz, BMW, Volvo and Land Rover. Inquire about some 1,000 items with OEM numbers or send samples for ...

RBH

YEE-SHIN BEARING CO., LTD.

No. 27, Chukuang Rd., Sanyi Borough, Yuanlin Town, Changhua County, Taiwan 510

Tel:886-4-833-5733, 833-3638

Fax:886-4-835-7576

E-mail: sp658@yahoo.com.tw

Website: www.yeeshin.com.tw

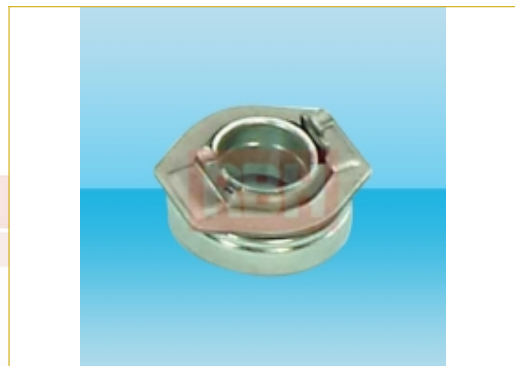

RBH.NO: 472921



RBH.NO: BC3556

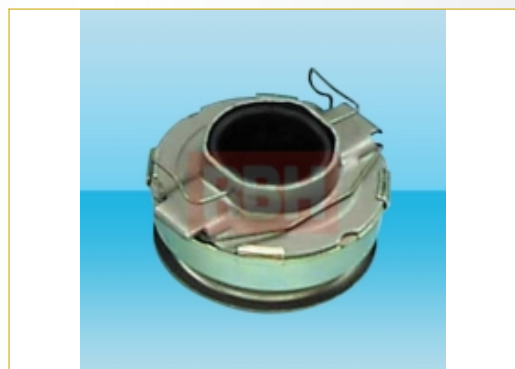

RBH.NO: BC3643

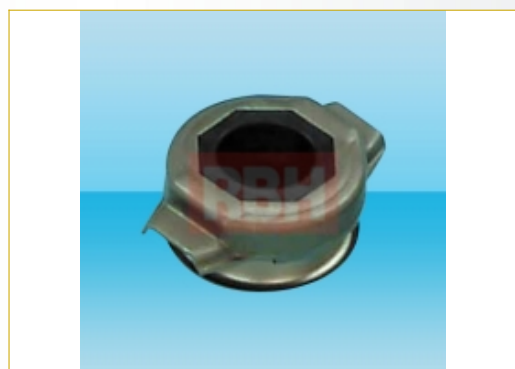

RBH.NO: BC3610

YOKOMA AUTO CO., LTD.

**Brake System, Suspension Parts,
Engine Valves, Water Pumps, Drive
Shafts, C.V. Joints, Universal Joints,
Brake Masters**

YOKOMA AUTO CO., LTD. is dedicated in Brake System, Suspension Parts, Engine Valves, Water Pumps, Drive Shafts, C.V. Joints, Universal Joints, Brake Masters, Wheel Cylinders, Brake Linings, Brake Shoes, Brake Pads, Brake Discs, Brake Drums, Brake Calipers, Control Arm, Ball Joint, Shock Absorber with operations in Taiwan



Brake System Parts

YOKOMA AUTO CO., LTD.

3F., NO.367, XINHU 2ND RD., NEIHU DIST., TAIPEI
CITY 11494, TAIWAN

Tel:886-2-2790-2011

Fax:886-2-2790-2711

E-mail: iris@yokoma.com.tw

Website: www.yokoma.com.tw



Engine Fittings

JOY TIME INDUSTRIAL CO., LTD.	50
CHYUAN CHANG INDUSTRIAL CO., LTD.	51
DEUSIC AUTOPARTS CO., LTD.	52
GLOSO TECH. INC.	53
GOLDEN BLOOM LTD.	54
JIN BAO YUH INDUSTRY CO., LTD.	55

JOY TIME INDUSTRIAL CO., LTD.

Air Filters, Oil Filters, Fuel Filters

JOY TIME Industrial Co., LTD. was founded in 1980 in Taiwan. JOY TIME is a factory making OIL, AIR and FUEL filters. We had got the ISO-9001 license form BSI in England. So we can supply the best Quality Control to our customer. We produce automatically by the latest machines like 4 LASER M/C, 500TON PRESSERR M/C...else. JOY TIME also supplies products to the OEM factory (ex: FRAM. HARLEY D....).Our main market includes AMERICAN, CANADA, EUROPEAN and JAPAN.



JOY TIME INDUSTRIAL CO., LTD.

32-9 Ma Tou Kou, Ma Tou Dist. Tainan City Taiwan

Tel:886-6-570-1261/4

Fax:886-6-570-0321

E-mail: joytime@jtfilter.com.tw

Website: m.cens.com/s/74705159



OIL FILTERS FOR AUTOMOBILE
AND MOTORCYCLE



FUEL INJECTION FILTER



AIR OIL FILTER FOR MOTORCYCLE



AGRICULTURE AND INDUSTRIAL
PARTS

CHYUAN CHANG INDUSTRIAL CO., LTD.

Gas Tanks, Oil Pans, Fuel filler neck, Gas tanks fitting, Straps

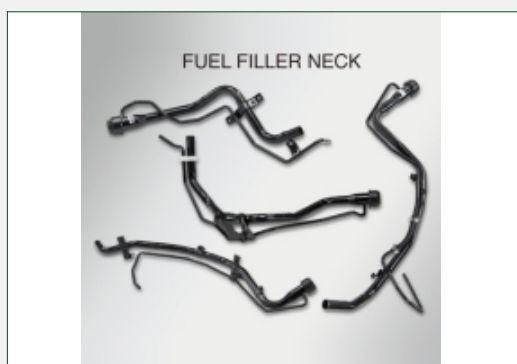

Fuel Filler Neck

CHYUAN CHANG INDUSTRIAL CO., LTD. is dedicated in Gas Tanks, Oil Pans, Fuel filler neck, Gas tanks fitting, Straps with operations in Taiwan



Oil Pan



Truck Tank



Straps



CHYUAN CHANG INDUSTRIAL CO., LTD.

No. 41-1, Houhsi Lane, Yuanlu Rd., Hsihu Town, Changhua County, Taiwan 514

Tel:886-4-881-8906

Fax:886-4-881-8039

E-mail: chyuan8@ms61.hinet.net

Website: m.cens.com/s/16728007

DEUSIC AUTOPARTS CO., LTD.

Fuel Filters, Air Filters, Oil Filters, Transmission Filters, Engine Fitting Parts, Auto Parts and Accessories

Deusic Autoparts Co., Ltd. manufactures and distributes all kinds of filters for Automotive, doing business throughout the North, Central and South America, Europe and Asia. Deusic filtration group was established in 2001 in Chung Li, Taiwan, offers a level of service second to none throughout the industry. Our 1000 M2 warehouse and distribution center offers a substantial inventory to fulfill your company's needs.



Fuel Filters

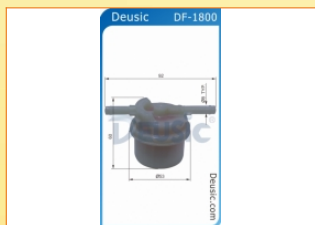

Fuel Filters



Fuel Filters



Fuel Filters

DEUSIC AUTOPARTS CO., LTD.

271-26 Nantung Rd., Pingchen City, Taoyuan County,
Taiwan 324

Tel:886-3-439-7126/8

Fax:886-3-439-7228

E-mail: sales@deusic.com

Website: www.deusic.com

GLOSO TECH. INC.

Circuit Breaker, Circuit Protectio, Waterproof, Overload Protect, Motor Protect, Ignition Protect, Switches, Marine

Founded in 1985, GLOSO Tech Inc., acting as a domestic importer for well-known AC/DC switches and circuit protection products, over the years developed into a world class supplier of quality switches and circuit breakers. In 1996, we set up shop in the City of Dongguang where our factory, TopStone, is in full operation to this day.

TopStone also happens to be the name of our flagship brand. We manufacture and assemble our products in-house with the best and the brightest RD, Production and Engineering teams in the industry. We specialize in OEM, ODM and also private label service. GLOSO's main headquarters is located in Taipei, Taiwan, with three sales offices in Taiwan, two in China, and two factories in China. We follow the strictest guidelines in the manufacturing of our products, and our entire inventory meets all the safe ...



GLOSO TECH. INC.

P.O. Box 24-45, Panchiao, Taipei Hsien, Taiwan

Tel:886-2-2964-3330

Fax:886-2-2964-3340

E-mail: cens@gloso.com.tw

Website: www.cens.com/gloso



E9 Hi-Amp Circuit Breaker



E39 ATO/ATC Circuit Breaker



E5 Stud Type Circuit Breaker, Shortstop
Circuit Breaker



A/J/S Hydraulic Circuit Breaker

GOLDEN BLOOM LTD.

Auto Parts, Reusable Swivel Hose Ends, Gutter Swivel Fittings, Stainless Steel, None Swivel Fitting, Twist & Fit Hoes Fittings, Radiator Hosing, Engine

Golden Bloom was fund at 2001 March 26 in China. It is a ISO 9001 certified company that produce all the products for Automotive aftermarket accessories and Race car industrial from Aerospace light weight fittings and hoses plus all the race car quick shifters. Golden Bloom has the capacity for all the new products develop and engineer for all the re-designed modify products. It is really a purely high performance products maker that serve for USA and other countries from Taiwan till in China for over than 20 years of experience that make sure it will happen for al ...



Aluminum An Fittings



Push On Fittings



TPFE Hose Fittings



Forged Angle Aluminum Fittings

GOLDEN BLOOM LTD.

Xin Cheng Industrial Area, Qiaotou Town, Dongguan, Guangdong Province, China

Tel:86-769-8345-5553

Fax:86-769-8334-7603

E-mail: tom@golden-bloom.com

Website: www.golden-bloom.com

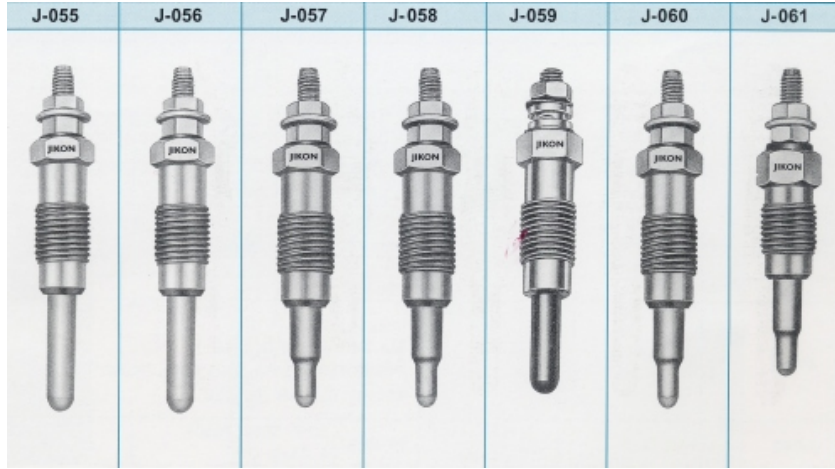

Glow plug

JIN BAO YUH INDUSTRY CO., LTD.

Tel:886-4-2486-4326
 Fax:886-4-2486-4265
 E-mail: jbe.plug@gmail.com
 Website: www.cens.com/jinbaoyuh

Established in 1997 as a specialist in glow plugs and other auto electrical parts & accessories, we distribute products worldwide under the "JIKON" brand name. which has successfully penetrated markets as the Middle East, Southeast Asia, and Latin America due to superior, high quality products. Insisting on offering excellant quality products, we take pride in being able to pass a series of QC inspecti ...

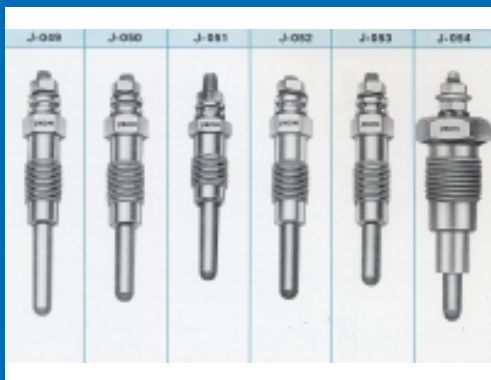

Glow plug

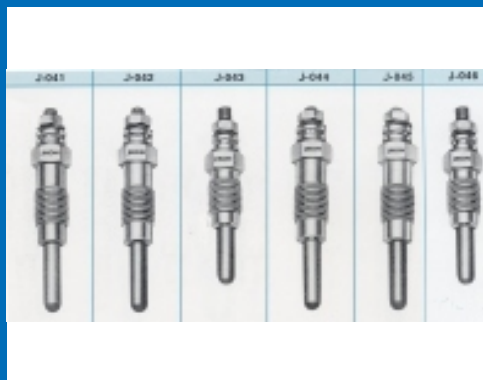

Glow plug

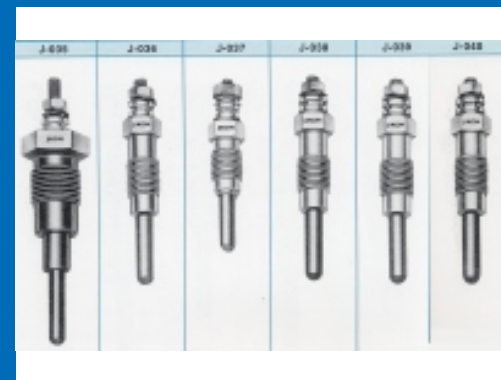

Glow plug

GOLDEN
48hr



48hr to your desired supplier

Go to **CENS.com**, and click on the button
“Customized Sourcing” by the search bar to
fill in an inquiry form. Within **48 hours**, you’ll
receive information you ask for!



CENS.com

buyerservice@cens.com



Exhaust System Parts

LUCRE STAR INDUSTRY CO., LTD.

58

SSI EXHAUST INDUSTRIAL CO., LTD.

60

LUCRE STAR INDUSTRY CO., LTD.

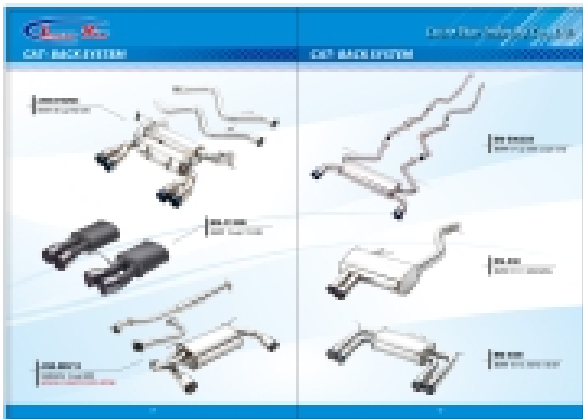

Exhaust System

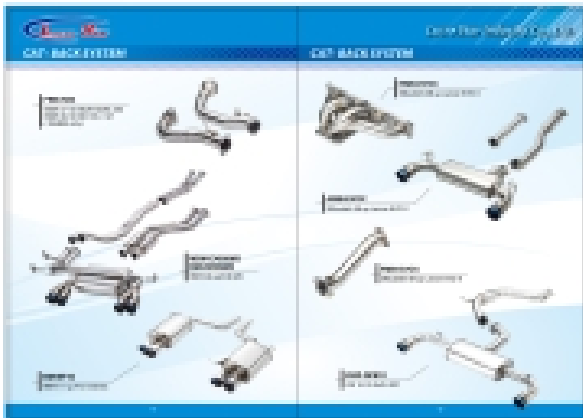

Cat-Back Exhaust System



Cat-Back Exhaust System



METALLIC CATALYTIC

Established in 1977 and located in the middle of Taiwan, Changhua, with 100 persons of workforce and 108,000ft2(9,900M2) floor area, Lucre star has been in the Automobile Parts Industry for almost 3 decades, who is one of the most professional manufacturers in Taiwan. We specialize in Exhaust systems, Tuning & Performance parts including Headers, Down pipes, Resonators, Middle Sections, full Cat.-Back & Axle Back systems, Universal Mufflers & Tips etc. Owing to so many years experience in this field. We also carry a full range of Conventional Exhaust systems



LUCRE STAR INDUSTRY CO., LTD.

No.11, Houlu Lane, Shanchiao Rd., Sec. 4, Shetou Township, Changhua County, Taiwan 511

Tel:886-4-871-0437

Fax:886-4-872-8655

E-mail: lucrstar@ms55.hinet.net

Website: www.lucrestar.com.tw

Exhaust Muffler Systems, Headers (Manifolds), Catalytic Converters, Cat Back Exhaust Systems, Axle Back, Stainless

Lucre Star Industry Co., Ltd.

MUFFLER

 **Tunable Muffler**
 **Adjustable Muffler**
 **Bullet-Round Muffler**
 **Carbon Fiber Muffler**
 **Titanium Muffler**
 **Bullet-Oval Silencer**
 **M1 Sport Silencer**
 **M2-Competition Silencer**
 **Twin Muffler**

EXHAUST TIP

TITANIUM EXHAUST TIP

 **TO-122x76VR**
 **TO-835RR**
 **TO-835SR**

TIPS TYPE

 **Flat**
 **Slant**
 **Rolled and Flat**
 **Rolled and Slant**

Item No.	Size(OxIDxL)	Type	Item No.	Size(OxIDxL)	Type
TO-835R	80x31x158L	Flat	TO-1028R	102x40x190L	Flat
TO-835RS	80x31x158L	Slant	TO-1028RS	102x40x190L	Slant
TO-835RF	80x31x158L	Rolled and Flat	TO-1028RF	102x40x190L	Rolled and Flat
TO-835RSL	80x31x158L	Rolled and Slant	TO-1028RSL	102x40x190L	Rolled and Slant
TO-835RSL	80x31x158L	Flat	TO-1139R	113x47x200L	Flat
TO-835RSL	80x31x158L	Slant	TO-1139RSL	113x47x200L	Slant
TO-835RSL	80x31x158L	Rolled and Flat	TO-1139RSL	113x47x200L	Rolled and Flat
TO-835RSL	80x31x158L	Rolled and Slant	TO-1139RSL	113x47x200L	Rolled and Slant

STAINLESS STEEL EXHAUST TIP WITH SPECIAL COLOR TREATMENT

Use high-technology to have various color treatment.

 **SS-113x77FS-C**
 **SS-835SP2-B**
 **SS-1028SP2-C**

 **BZ-219**
For Benz W218

 **PH-937**
For Porsche 937

 **BZ-2265C**
For Benz W200

Transformed Direct-fit Muffler



UNIVERSAL TIP

Item No.	Size(OxIDxL)	Type
UT-001	80x31x158L	Flat
UT-002	80x31x158L	Slant
UT-003	80x31x158L	Rolled and Flat
UT-004	80x31x158L	Rolled and Slant
UT-005	102x40x190L	Flat
UT-006	102x40x190L	Slant
UT-007	102x40x190L	Rolled and Flat
UT-008	102x40x190L	Rolled and Slant

Universal Tip



MANDREL BENDS

Item No.	Size(OxIDxL)	Type
MB-001	80x31x158L	90°
MB-002	80x31x158L	45°
MB-003	102x40x190L	90°
MB-004	102x40x190L	45°

MANDREL BENDS

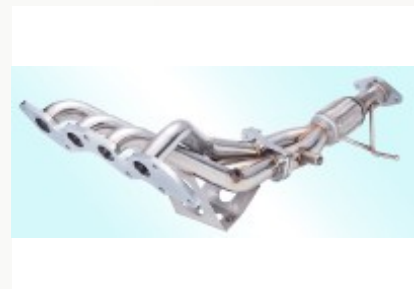

High Performance Headers

SSI EXHAUST INDUSTRIAL CO., LTD.

SSI Exhaust, Manifold, Header, Air Filter, Cold Air Intake, Turbo Exhaust Manifolds, Turbo Outlets, Hose Clamps

We are one of the leading manufacturers of high performance Exhaust Turbo Manifold and Outlets in 2000. Our manifolds are designed to increase horsepower and torque by freeing up the exhaust and allowing spent gases to flow out of the cylinder more efficiently. Our Technology Skill: By our excellent bending and welding skill, we make the specialty of our manifolds - No easy cracking & smooth inner surface.

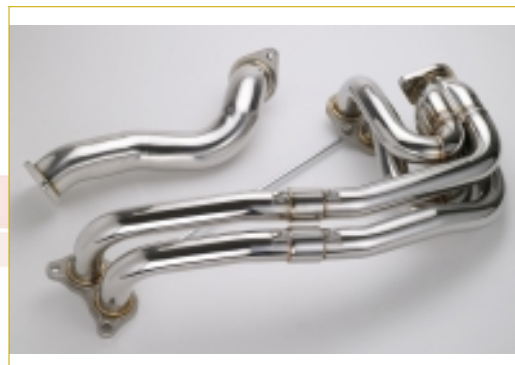

Toyota FT86 Header



American Type Hose Clamp



Butterfly Handle Type Hose Clamp



Heavy Torque Hose Clamp



SSI EXHAUST INDUSTRIAL CO., LTD.

7th Fl., No. 124-2, Minquan E. Rd., Sec. 3, Taipei, Taiwan 105

Tel:886-2-2545-3770

Fax:886-2-2546-9390

E-mail: sales@ssiexhaust.com.tw

Website: www.ssi-2735.com.tw



Cooling System Parts

CHIN LANG AUTOPARTS CO., LTD.	62
ENERGY SKIP ENTERPRISE CO., LTD.	63
FWU YIH BRASS ENTERPRISE CO., LTD.	64
HSI TO TSUN ENTERPRISE CO., LTD.	65
SHEN MENG TRAFFIC EQUIPMENT CO., LTD.	66
SIGMA AUTOPARTS CO., LTD.	67
TSAN HSIN IND. CO., LTD.	68
YANG SAN ENTERPRISE CO., LTD.	69
YOUNG SHINE ELECTRIC CO., LTD.	70

CHIN LANG AUTOPARTS CO., LTD.

Windshield Washer Pumps, Washer Nozzles, Wiper Motors, Ignition Switches, Wiper Links, Cooling Fan for Radiator

CHIN LANG is a leading manufacture and exporter of autoparts in Taiwan, established in October 1980, specializes in Auto windshield washers and electric parts. Its products include windshield washers, washer pumps, washer nozzles, wiper motors, wiper links, antennas, fuel gauges, cooling fans for radiators, cooling fans for air conditions, auxiliary, and so on. CHIN LANG is dedicated to research and development, which has improved the quality of its products and increased its production capacity. Its products have been exporting to overseas which are including Europe, America, Asia, Australia and Africa for the after-market for almost twenty years. The company's features are high mobility and cooperation, it is a very good OEM partner to reach the highest mutual benefit. So it is not only the supplier of the local car's makers and also i ...

CHIN LANG AUTOPARTS CO., LTD.

No. 6, Alley 46, Lane 30, Lihsing Rd., Sec. 2, Sanchung Dist., New Taipei City, Taiwan 241

Tel:886-2-2988-3131

Fax:886-2-2988-1231

E-mail: info@chinlang.com.tw

Website: www.chinlang.com.tw



Fuel Sending Unit



Washer Nozzle



Windshield Washer



Radiator Spare Tank

ENERGY SKIP ENTERPRISE CO., LTD.

Thermostat, Thermo Sensor, Ignition Coil, Ignition Module

ENERGY SKIP ENTERPRISE CO., LTD. was established in 1995, specializing in providing cooling and ignition systems. RPE is one of the brands created by ENERGY SKIP ENTERPRISE CO., LTD. The products we carry are covering all kinds of cars from all the car companies. We provide products of high quality and competitive unit prices to all the partners selling automobile parts around the world. It's our pleasure to provide the best service to you, no matter where you are. If you have any questions about RPE products, please feel free to contact us. We'll be more than happy to provide answers to your questions.

ENERGY SKIP ENTERPRISE CO., LTD.

1st Fl., No. 14, Lane 175, Taiyuan Rd., Taipei City, Taiwan 103

Tel:886-2-2550-7292

Fax:886-2-2550-7584

E-mail: esemotor@ms64.hinet.net

Website: www.cens.com/energy



Thermostat-WV52BC-71C



PCV VALVE



thermostat seal



Radiator cap

FWU YIH BRASS ENTERPRISE CO., LTD.

ball valves, ball cocks, brass adapters, forging elbows, quick connectors, saving fittings, spray parts, air parts, steel connector

Established in 1989, the company is specialized in copper products and engaged in the development of copper parts. Over one thousand of products and thousands of speculations, the products mainly apply for hydraulic pressure and oil pressure accessories and also for water, gas, automotive and electronic parts and accessories. For better quality, lower cost and new product development, the company has purchased latest machines and equipments in succession these years for market demands, which also presents our spirits of innovation.



Fitting Tube Double(Stainless)



Female Forging Tee



Elbow Connector



Male / Inlet Type With Pvc Washer



FWU YIH BRASS ENTERPRISE CO., LTD.

122 Chuwei Lane, Chao-an Borough, Lukang, Changhua County, Taiwan 505

Tel:886-4-774-8520

Fax:886-4-774-4570

E-mail: et200131@seed.net.tw

Website: www.cens.com/fwuyih

HSI TO TSUN ENTERPRISE CO., LTD.

Radiator Caps, Cooling System Parts, Air-Conditioning Systems, Engine Parts, Auto Accessories

Radiator caps: We specialize in making automotive radiator caps and established in 1979. All of our products are 100% warranty and high quality. Your satisfy is our business. We research New Safe Thermo Radiator Cap and obtained two patents. It is with safety as the purpose, develop for reminding the driver. Safe Thermo Radiator Cap has a built in thermometer that displays your coolant temperatures whether in a safe situation or not. When the driver must remove the cap urgently, it can be sure of the temperatures. Besides, there is color line on the gauge face, from green, yellow to red, so it's clearer to understand the timing to remove the cap. It also gives your car's engine system a shining and unique look. Using Safe Thermo Radiator Cap could protect you and your valuable investment. Our products apply to Japanese, Korean cars and heavy ...

MODEL: T148 1.8KG
Motorcycle Safe Thermo Radiator Cap



HSI TO TSUN ENTERPRISE CO., LTD.

Safe Thermo Radiator Cap (Motorcycle)



FEW Automotive Radiator Cap

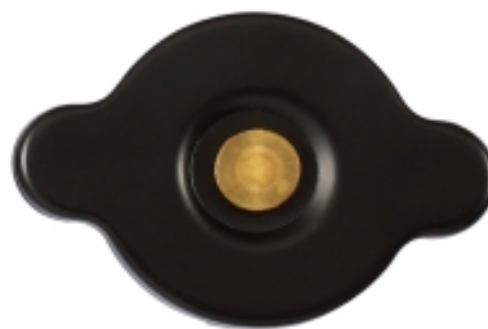

Automotive Radiator Cap



FEW Packing Box

HTT

HSI TO TSUN ENTERPRISE CO., LTD.

No. 218-28, Lane 600, Xiandong Rd., Sec. 1, Changhua City, Taiwan 500

Tel:886-4-763-6390

Fax:886-4-763-1028

E-mail: hsito.tsun@msa.hinet.net

Website: www.hsitotsun.com

SHEN MENG TRAFFIC EQUIPMENT CO., LTD.

**Fuel cock, Fuel Pump, Oil Pump,
Tran. Tie Rod, Ball Joint, Brake
Shoe, Water Inlet, Throttle Hing,
Carburetor**

Professional manufacturer of auto, motorcycle parts

SHEN MENG TRAFFIC EQUIPMENT CO., LTD.

1st Fl., No. 152, Lane 169, Dinchao Rd., Sec. 3, Lugang
Town, Changhua County, Taiwan 505

Tel:886-4-771-1256

Fax:886-4-771-4048

E-mail: fuelcock@ms37.hinet.net

Website: www.shenmeng.com



fuel cocks, fuel pumps, transmission tie
rods, ball joints, and throttle hinges



fuel cocks, fuel pumps, transmission tie
rods, ball joints, and throttle hinges



fuel cocks, fuel pumps, transmission tie
rods, ball joints, and throttle hinges



fuel cocks, fuel pumps, transmission tie
rods, ball joints, and throttle hinges

SIGMA AUTOPARTS CO., LTD.

Body Parts, Piston, Piston Ring, Alternator, Starter, Ignition Coil, Ignition Module, Oil Pump, Fuel Pump, Water Pump, Gasket, Radiators, Radiator Cap

SIGMA AUTOPARTS CO., LTD is located in southern Taiwan. It is an excellent and one of the most competitive wholesalers in the auto parts industry. As being a professional auto parts exporter and importer in Taiwan where there are many automobiles on the road, Sigma works actively and passionately in this field, continues to move forward, in hopes it can provide the world market with more diversity and pleasant options.



Starter



Window Regulator

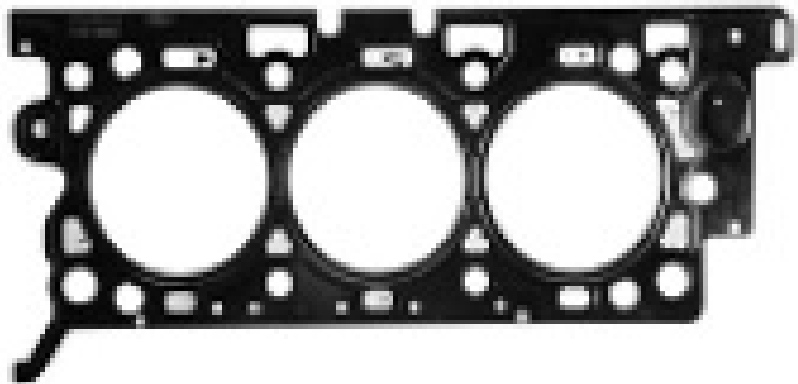

Gasket



SIGMA AUTOPARTS CO., LTD.

No. 66-1. Yongfang Rd., Daliao Dist., Kaohsiung City, Taiwan 83158

Tel:886-7-781-7162

Fax:886-7-783-2060

E-mail: sigma.autoparts@gmail.com

Website: www.cens.com/sigma

TSAN HSIN IND. CO., LTD.

Hydraulic Vertical Broaching Machines

Tsan Hsin is a dedicated manufacturer of hydraulic broaching machines. President Wen Ching Hsu added that broaching machines and equipment are used to make every kind of mass produced products. In fact, a wide range of manufacturing industries use these machines including the automotive part (gear wheels, keyway, brake systems), bicycle component, boat (propellers, rudders), computer part (heat sinks), exercise and recreational equipment (paintball guns) and hand tool (open-end wrenches, screws) fields. For thanks to many companies' support, we are absorbed in research and development more high quality and efficiency design of broaching machine in order to enhance its practical utility and make it more outstanding. For many years, our quality control system already been identified with other companies in the same field, with the enthusiasm and



TSAN HSIN IND. CO., LTD.

No. 326, Yungping Rd., Sec. 2, Taiping Dist., Taichung City, Taiwan 411

Tel:886-4-2275-5811

Fax:886-4-2270-0800

E-mail: tsanhsin@tsan-hsin.com.tw

Website: www.cens.com/tsanhsin



Vertical internal broaching machines,
Hydraulic broaching machines



Vertical internal broaching machines,
Hydraulic broaching machines



Broaching Machines: Internal Automatic
Tool-Lifting



Broaching Machines: Internal

YANG SAN ENTERPRISE CO., LTD.

Fuel Level Sensor, Fan Control Units, Combination Switch, Power Window Switch, Hand Pump, Switch, Impulse Sensor

Founded in 1986, we specialize in auto part/component R&D & manufacture and already have products successfully penetrated into countries in Europe, Asia, and the U.S. Our motto is provide Superior Materials, Well-organized Design & Production, Whole-hearted Service, Stringent Management, and Quality Products to Win Customers' Trust; and main products are fan control modules, vehicle speed sensors, power window switches, fuel level sensors, turn signal switches, water level sensors, resistors, ignition coil modules, etc. With headquarters locate in Hsinchuang City, Taipei County, Taiwan, please contact us for further info.



Combination Switches



Power Window Master Switch



Speedometer



Fuel Level Sensor

YANG SAN ENTERPRISE CO., LTD.

No. 40, Alley 116, Lane 139, Gongwu Rd., Longtan Township, Taoyuan County, Taiwan 325

Tel:886-3-479-8877

Fax:886-3-489-7333

E-mail: service@ys.com.tw

Website: www.ys.com.tw

YOUNG SHINE ELECTRIC CO., LTD.

Air Conditioner Compressor

YOUNG SHINE ELECTRIC CO., LTD. is dedicated in
Air Conditioner Compressor with operations in Taiwan



Air Conditioner Compressor

YOUNG SHINE ELECTRIC CO., LTD.

Tel:886-7-8228183

Fax:886-7-8228178

E-mail: service@young-shine.com.tw

Website: www.young-shine.com.tw

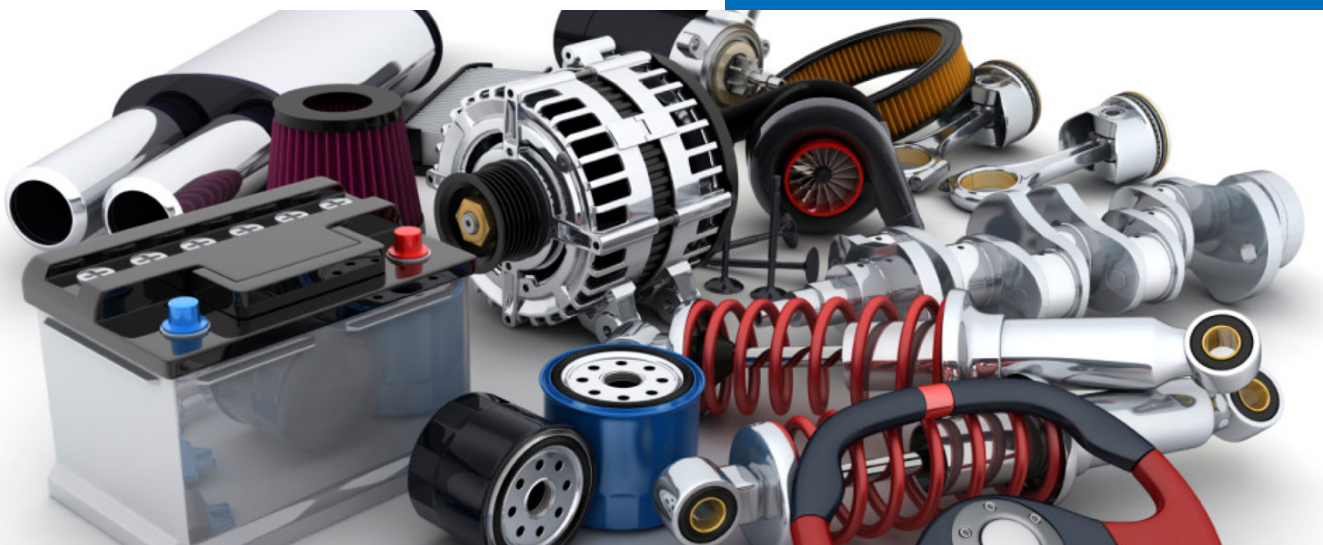

Electrical Parts

CHIEN LI ENTERPRISE CO.	72
L & S (TAIWAN) ALLIED CO., LTD.	73
MEGGIS ENTERPRISE CO., LTD.	74
MULTIVICTOR TECHNOLOGY CO., LTD.	75
TIEN YEH ENTERPRISE CO., LTD.	76
YANG SING PRECISION CO., LTD.	77

CHIEN LI ENTERPRISE CO.

Switch, Relay, LED

PRD: Auto Lamps, Switches for Auto Engines and Marine Vessels, as Well as Toggle Switches



Ignition Starter Switches



LED Lamps



LED Lamps



Ignition Starter Switches

CHIEN LI ENTERPRISE CO.

No. 10, Lane 37, Annan Dist., Sec. 6, Fu'an Rd., Tainan City, Taiwan 709

Tel:886-6-259-6724

Fax:886-6-259-4328

E-mail: chienli.tainan@gmail.com

Website: www.cens.com/chienli

L & S (TAIWAN) ALLIED CO., LTD.

Electrical Terminal, Connector, Wiring Parts, Tester, Tool & Assortment, Solderless Terminals, Crimpers, Strippers & Cutters

L & S (TAIWAN) ALLIED CO., LTD., is one of the largest manufacturer and exporter of Electrical Terminals, Tools, Kits, Wiring Accessories, and Marine Accessories for Automotive, Marine, and Household industries here in Taiwan since 1976. With over 35 years of expertise in the industry, we guarantee to supply diverse lines of high-quality products/customization/consolidation service and satisfying one-stop shopping experience at competitive prices.



Marine Hardwares & Accessories



Fuse & Fuse Holder Accessories



Electronic Repair Kits



Electrical Hand Tools

L & S (TAIWAN) ALLIED CO., LTD.

P.O. Box 36-621, Taipei, Taiwan

Tel:886-2-2406-3099

Fax:886-2-2406-2579

E-mail: ls@termico.com.tw

Website: www.termico.com.tw

MEGGIS ENTERPRISE CO., LTD.

Auto Electronic Parts & Components, Adaptors Converters Inverters

All Products Made In Taiwan We Manufacture Components Since 1975 You Can Count On Us

Main Products: Rocker Switches Toggle Switches Marine Switches Electronic Components



Switch Panel



Push-Pull Switches



Terminal Blocks



Emergency Cut-Off Switch

MEGGIS ENTERPRISE CO., LTD.

No. 100, Alley 247, Dachiao 1st St., Youngkan Dist., Tainan City, Taiwan 710

Tel:886-6-232-1101

Fax:886-6-233-4195

E-mail: megi0428@ms15.hinet.net

Website: www.taiwantrade.com.tw/MGSSwitches

MULTIVICTOR TECHNOLOGY CO.,

Wire Harness Assembly, Auto Parts, Connectors, Car Accessories, Waterproof Wiring Harness

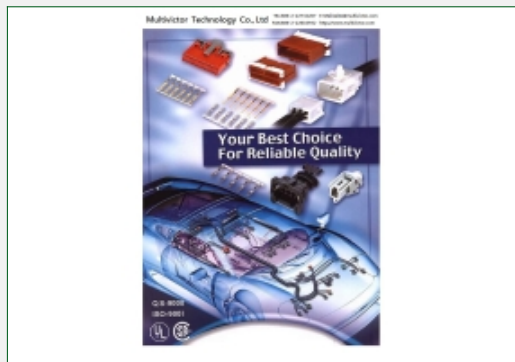

Connector-1

Multivictor Technology Co., Ltd. Granted ISO 9001/TS 16949 was established in 1994 and we are a professional manufacturer and exporter mainly for OEM/ODM Automobile and Motorcycle Wire Harness Assembly, Waterproof Wire Assembly & connectors for car audio, wire assembly & connectors for head lamp, wire assembly for the Motor, wire assembly electric vehicle, wire assembly for ATV, water proof connectors and also the communication wire assemblies & LED Auto Fuse etc. With our own toolings for the equivalents of connectors like YASAKI, SUMITOMO, FURUKAWA, MISUBISHI, MAZDA, MOLEX, HRS, TYCO, AMP, RAYCHEM, DELPHI, FCI, GHW, JST, U.S, FORD, ETC. We can provide you more options of favourable connectors and the prompt deliveries. Our main target customer groups are in the respect of automobile, motorcycle, computer, elec ...



Main Wiring Harness Assemblies

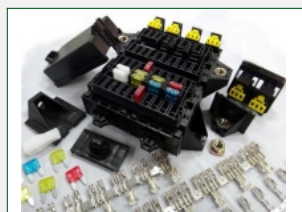

FUSE BOX- MVTYFB(20P)



Waterproof & Electronic cable Assemblies



MULTIVICTOR TECHNOLOGY CO., LTD.

8th Fl.-1, No. 258, Chincheng Rd., Sec. 2, Tucheng Dist., New Taipei City, Taiwan 236

Tel: 886-2-2273-2267

Fax: 886-2-2261-0932

E-mail: sales@multivictor.com

Website: www.cens.com/multivictor



- EMS電腦主配線
EMS wiring harnesses
- 晝行燈線組
Wiring harnesses for day running lights
- 機車漫遊燈
Motorcycle-use scattering lights
- H3通用霧燈線組
H3 universal wire assemblies for fog lamps
- H4大燈強光線組
H4 light booster wire assemblies for headlamps
- HID氙氣大燈線組系列
HID xenon headlamp wire assemblies
- 機車LED殺陣后燈組
Motorcycle LED Taillamps

- 汽機車LED燈具類PC板組立(含承製與設計)
- 汽機車專用(通用)接頭
- H1, H7, H11, H13, 9005, 9006 專用接頭

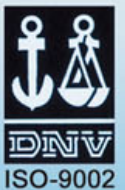

典業企業有限公司
TIEN YEH ENTERPRISE CO., LTD.
 No. 252, Kingmon St., Panchiao, Taipei Hsien, Taiwan 220
 Tel: 886-2-2682-2287 Fax: 886-2-2683-9630
 E-mail: q74212@ms48.hinet.net

YANG SING PRECISION CO., LTD.

Combination Switch, Starter Switch, Ignition Module, Wire Harness Assy, Pitman Switch, Door Lock, Control Cable, Ignition

YANG SING PRECISION CO., LTD. established since 1978, is a professional manufacturer of various automobile switches. The major products are: TURN SIGNAL SWITCH HORN PIN. DOOR SWITCH IGNITION CABLE SWITCH IGNITION STARTER SWITCH DOOR LOCK W/KEY TRUNK LID LOCK W/KEY FUEL DID LOCK W/KEY KEY SET AIRCON SWITCH & POWER WINDOW SWITCH The founder, Mr. Yang, Wen-Shien, President of YANG SING, is a technician, a designer and an engineer, with accumulated 26 years' experience in Switches/Keys field, that creates YSM products always the most Precisely, the most efficient and the most popular in the market. President Yang believes, Technology is the Soul of YANG SING and custome ...

YANG SING PRECISION CO., LTD.

P.O. Box 2-28, Shulin Dist., New Taipei City, Taiwan

Tel:886-2-2689-1978, 2689-6146

Fax:886-2-2689-4563

E-mail: ysm@ysmtw.com

Website: www.ysmtw.com



COROLLA



306 '97 UP

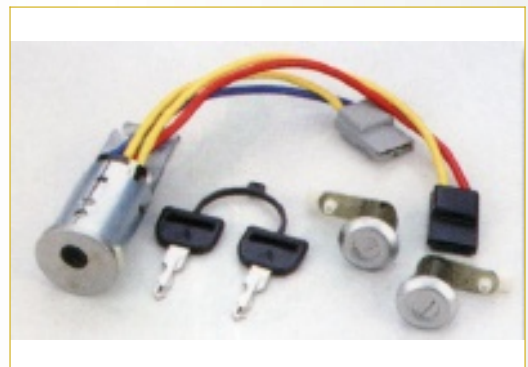

AX



CLIO '92 UP



Air-Conditioning Systems

JOYWELL MOTOR CORPORATION

79

JOYWELL MOTOR CORPORATION

Cylinder Liners, Pistons, Piston Rings, Engine Valves

1.ISO9002 Quality Assurance 2.50 Years Of Experience 3. Automatic & Advanced Production Equipments 4. Strict Quality Control System We have been in manufacturers for cylidner liner / sleeves, piston assy, liner kits & engine bearings for more than 50 years. We also can offer you used parts / complete engines with gear box / cabs / front & rear alxes & complete trucks from korean & Japan if you are interested. We have been in this business for more than 15 years. We are sure that our high quality of goods, very reasonable prices and best services would be the one that you can rely on for long term business. We are waiting for your reply very soon. Following new spare parts we can offer you, Truck parts, Auto parts, Engine part ...



JOYWELL MOTOR CORPORATION

12F-2, No. 787, Zhongming South Rd., Taichung, Taiwan 40255

Tel:886-4-3500-8377(Rep.)

Fax:886-4-3500-8378

E-mail: jmc.group@msa.hinet.net

Website: www.cens.com/joywell



DIESEL ENGINE PARTS



TRANSMISSION GEARS & PARTS



CYLINDER ASSEMBLY

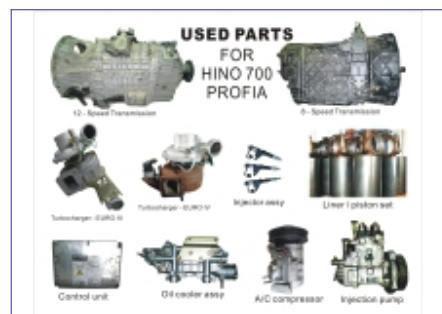

USED PARTS FOR HINO PROFIA 700 / E13C



Steering System Parts

A-ONE PARTS CO., LTD.	81
AL FORGE TECH CO., LTD.	82
ALTEZZA CO., LTD.	83
HWANG YU AUTOMOBILE PARTS CO., LTD.	84
HWANG YU AUTOMOBILE PARTS CO., LTD.	85
SLOOP SPARE PARTS MFG. CO., LTD.	86

A-ONE PARTS CO., LTD.

Center Bearing Support, Strut Mounting, Steering Gear Assy, Steering Coupling & Joint, Steering Couplings, Center Bearings Support

A-One Parts Co., Ltd. was building in 1989. "Where is the car, where is our parts" is not only our purpose but also our way. Our main production lists follow items:
CENTER BEARING SUPPORT ABSORBER
MOUNTING STEERING GEAR ASSY STEERING
COUPLING & JOINT The parts main exported for
United State, South East Asia and Austrilia. Secondary
market is West Europe, Modia South America, South
Africa and so on. Holding" Excellent Quality, Reasonable
Price and Prompt Serving" is our goal, thoroughly carries
out the symbol of perfect production so as to accept the
arrival of international trade liberalization. Welcome your
sample or drawing in advance, serving your is our
pleasure.

A-ONE PARTS CO., LTD.

No. 10, Alley 13, Lane 228, Taihsi S. Rd., Lungching Dist.,
Taichung City, Taiwan 434

Tel:886-4-2639-3000, 2639-3719

Fax:886-4-2630-3277, 2630-3655

E-mail: aonepart@ms38.hinet.net

Website: www.a-oneparts.com



CONTROL ARM



STRUT MOUNTING



STRUT MOUNTING



CENTER BEARING SUPPORT

AL FORGE TECH CO., LTD.

Aluminum Forging Component, Aluminum Control Arm, Hinges, Steering Knuckle, Brake Caliper

AL Forge Tech Co., LTD. is a professional aluminum alloy forging plant with 30 years of experience on aluminum alloy forging, and specializes in the aluminum alloy property, mold design, process design and key technology on heat treatment of aluminum alloy. As the rise of environmental consciousness and the promotion of reducing oil consumption, using aluminum alloy will be a trend in the future because of its light weight. Car factories will need more aluminum alloy. The demand of aluminum alloy will continue to grow. Forging items: automobile and motorcycle parts, bicycle parts and industrial hardware

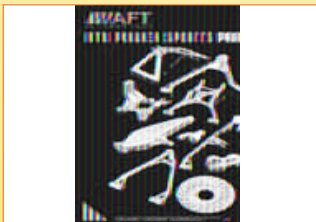

90x120-ATV POWER
SPORTS PARTS-2-02



Aluminum Forging
Component

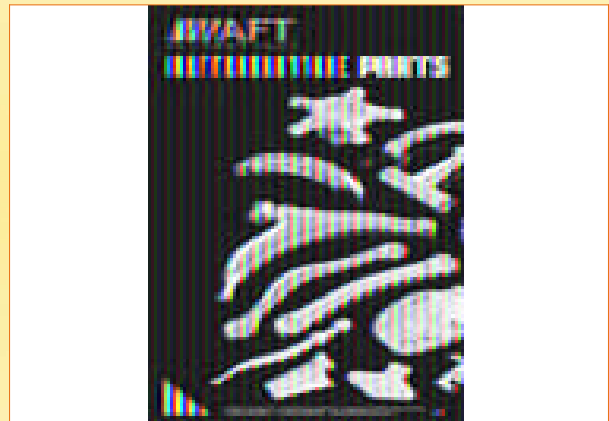

90x120-AUTOMOTIVE PARTS-02

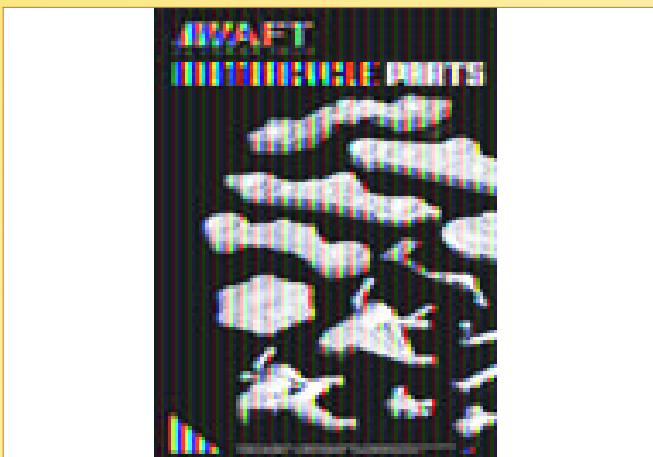

90x120-MOTORCYCLE PARTS-02

AL FORGE TECH CO., LTD.

No.67-21, Ln, 854, Sec. 1, Shatian Rd., Dadu Dist.,
Taichung City 432, Taiwan

Tel:886-4-2698-0058

Fax:886-4-26980368

E-mail: aft@aft-forge.com.tw

Website: www.aft-forge.com.tw

ALTEZZA CO., LTD.

Steering & suspension Systems (control arms)

THE ALTEZZA WAS ESTABLISHED IN 1986 AND HAVE SPECIALIZED IN THE FIELD OF AUTO SPARE PARTS FOR AFTERMARKET. "QUALITY AND SERVICE" ARE OUR COMMITMENT TO ALL OF OUR CUSTOMERS ALL OVER THE WORLD. OUR MAIN PRODUCTS RANGES ARE COVERING OF BRAKE SYSTEM, CV JOINTS, WATER PUMPS, BODY PARTS, CHASSIS AND STEERING PARTS AND OTHER ACCESSORIES. UNTIL SO FAR, WE HAVE SET UP 3 PRODUCTION LINES IN OUR OWN WHICH ARE MANUFACTURING OF BRAK ...

ALTEZZA CO., LTD.

9th Fl., 55 Hsinyi Rd., Sec. 4, Taipei, Taiwan 110

Tel:886-2-2708-8501

Fax:886-2-2708-8511

E-mail: public@altezza.com.tw

Website: www.kapars.com



WATER PUMP



WHEEL BEARING KIT



WHEEL HUB ASSEMBLY



BODY PARTS

HWANG YU AUTOMOBILE PARTS CO., LTD.

Chassis Parts, Ball Joints, Suspension Parts, Steering Parts, Calipers

Hwang Yu is a TS16949 and ISO 140001 certified company specializing in development and production of high-quality aftermarket automotive chassis and brake components, with over 46 years of manufacturing experience. The products are marketed worldwide with own-brand "Hwang Yu". Currently Hwang Yu supplies several major product categories; including ball joints, tie rod ends, rack ends, center links, and control arms, brake calipers etc. Hwang Yu has set up the most professional laboratories with various advanced testing/inspection equipment, including the reverse-engineering scanning machine, torque, impact, salt spray, hardness, durability, and mud/water tests, so as to simulate the real operation conditions without any tolerance. Manufacturing processes to satisfy customers' requirements, so it has been constantly improving its techniques, renewing eq ...



HWANG YU AUTOMOBILE PARTS CO., LTD.

No. 2, Alley 15, Lane 1, Sec. 4, Chungching N. Rd., Taipei,
Taiwan 111

Tel:886-2-2812-9311

Fax:886-2-2812-5406

E-mail: three5.hy@msa.hinet.net

Website: www.hwangyu.com



Tie Rod End



Ball Joint



Tie Rod End



Tie Rod End

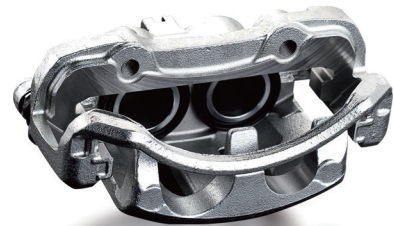

HWANG YU
AUTOMOBILE PARTS CO., LTD.

Office:
No. 2, Alley 15, Lane 1, Sec. 4,
Chungching N. Rd., Taipei, Taiwan 111
Tel: 886-2-2812-9311 Fax: 886-2-2812-5406
E-mail: three5.hy@msa.hinet.net
<http://www.hwangyu.com>

Factory:
No. 486, Sec. 1, Zhongyang Rd., Wuqi Dist.,
Taichung City 43546, Taiwan
Tel: 886-4-2639-2120
Fax: 886-4-2639-2070



SLOOP SPARE PARTS MFG. CO., LTD.

**Steering System Parts,
Transmission System Parts,
Suspension System Parts, Chassis
Parts, Power Transmission Systems,**

Sloop Spare Enterprise Co., Ltd. has done an excellent job in upgrading the precision of our products over the years since our establishment in 1984. Specializing in making a wide variety of auto steering systems. And have gained the approvals ISO 9001/2000. We will continue to develop and innovate, and to provide ever more quality auto parts. Our web site: www.sloopweb.com, contact us for further information. OEM and ODM orders are also welcome. Sloop is your best choice and faithful friend forever offer high quality. Products and the best excellent service for you.



Tie Rod End / Suspension Parts /
Steering Parts / Chassis Parts



Ball Joint / Suspension Parts / Steering
Parts / Chassis Parts



Inner Arm Shaft Kit / Suspension Parts /
Steering Parts / Chassis Parts



Inner Arm Shaft Kit / Suspension Parts /
Steering Parts / Chassis Parts



SLOOP SPARE PARTS MFG. CO., LTD.

Tel: 886-4-2389-1078

Fax: 886-4-2389-5488

E-mail: sloopweb@ms76.hinet.net

Website: www.sloopweb.com

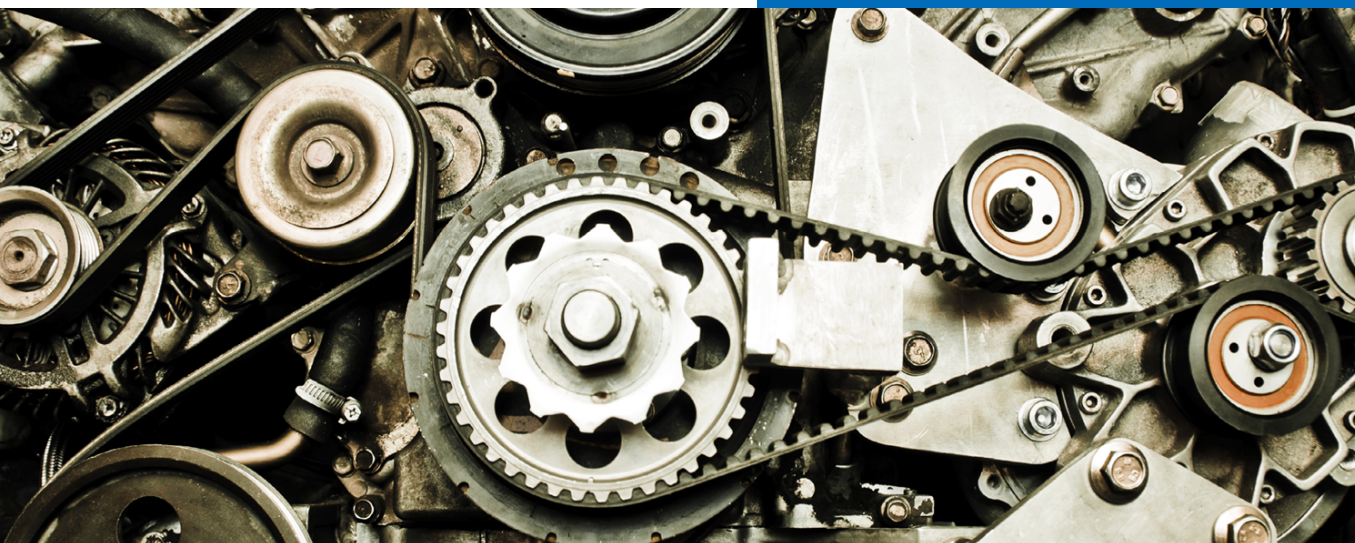

Transmission System Parts

LINESOON INDUSTRIAL CO., LTD.	88
ORIENTAL STAR CHEMICAL INC.	90
ADESCO INDUSTRIAL CO., LTD.	91
FU-SHEN INDUSTRIAL CO., LTD.	92
LINESOON INDUSTRIAL CO., LTD.	94
SHANG HAO PRECISION TECHNOLOGY CO., LTD.	96

LINESOON INDUSTRIAL CO., LTD.



AUTOMATIC TRANSMISSION PARES



DIAPHRAGM SPRING



RUBBER PISTON

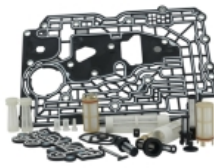

SCREEN FILTER

LINESOON INDUSTRIAL CO., LTD. is dedicated in Transmission System Parts, Clutch Plates, Clutch Facings, Transmission Components with operations in Taiwan

LINESOON INDUSTRIAL CO., LTD.

No. 466, Jhongshan Rd., Sigang Township,
Tainan County, Taiwan 723

Tel:886-6-796-1929

Fax:886-6-796-1932

E-mail: sales@linesoon.com.tw

Website: www.linesoon.com.tw

Transmission System Parts, Clutch Plates, Clutch Facings, Transmission Components



TRANSSION FILTER

ORIENTAL STAR CHEMICAL INC.

Boots, C.V. Joint Boots, Steering Rack Boots, Packing, Valve Seals, Shock Absorbers Boots, Bushings, Auto Rubber Parts

Our company "Oriental Star Chemical Inc." was established in 1991. It is located in Taichung, Taiwan. We have many years' experience in studying the rubber properties and designing relevant recipes for our customers. The various master batch accelerators and refined processing rubber produced by our factory can meet the special demand from different customers. Besides, our excellent technology in carbon black processing and the strict quality control are well acknowledge and accepted by our domestic and foreign customers.



ORIENTAL STAR CHEMICAL INC.

No. 171, Zhonghe St., Sec. 5, Xinshe Dist., Taichung City,
Taiwan 426

Tel:886-4-2582-1951/2

Fax:886-4-2582-5635

E-mail: osc@oriental-star.com.tw

Website: www.oriental-star.com.tw



Shock Absorber Boot, Shock Absorber
Cover



Shock Absorber Boot, Shock Absorber
Dust Cover



ATV, C.V. BOOT, ATV Shaft Dust
Cover, CV Joint Boot Dust Cover

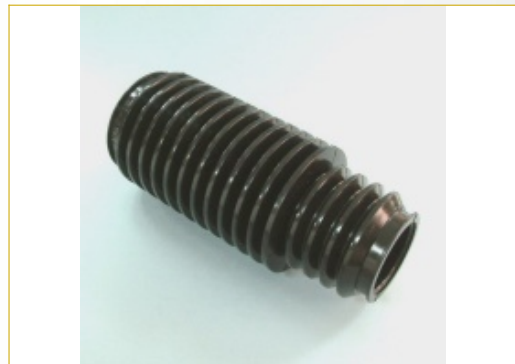

STEERING BOOT, Plastic Dust Cover



CHAINS & SPROCKETS

Your Quality and Reliable Chinese Source Since 1978

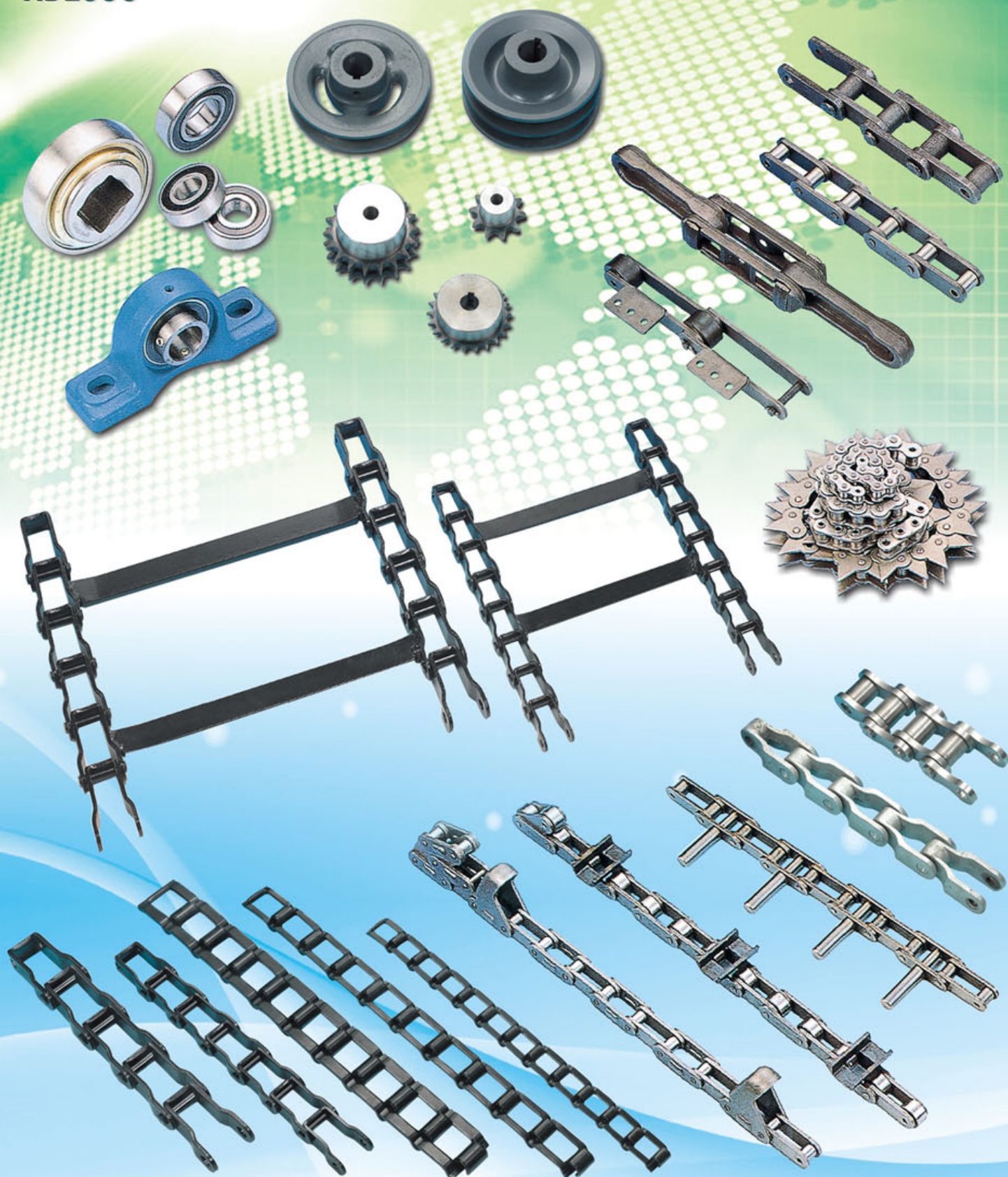

ADESCO INDUSTRIAL CO., LTD.

7F-4, No. 91 Hsin-Yi Rd., Sec. 2, Taipei 100, Taiwan

TEL: 886-2-2393-3263, 2356-3327 FAX: 886-2-2394-2420

E-mail: adesco@ms6.hinet.net <http://www.adesco.com.tw>



FU-SHEN INDUSTRIAL CO., LTD.

Transmission Gears, Different Gears for Automobiles, Auto Components, Rear-Wheel Transmission Shafts

We are FITORI (FU-SHEN) Industrial Co., Ltd., which was established in 1987 on producing various kinds of transmission and differential parts especially in gears to be specified in cars, light/duty trucks and forklifts/heavy equipment, we are dealing in after-market for the brands as Mitsubishi, Toyota, Isuzu, Nissan, Hino, Mazda, Scania, Mercedes Benz and ZF transmission gears ...etc. We are professional and have experienced in this field more than 25 years, our products have been promoted to various countries based on reasonable prices and quality reliability. Please kindly find our latest catalogues attached. If you are interested any item, please don't hesitate to contact us.



4TH SPEED GEAR



SLEEVE & HUB 3-4



5TH SPEED GEAR



INPUT SHAFT, COUNTER GEAR

FU-SHEN INDUSTRIAL CO., LTD.

No. 20, Alley 61, Lane 257, Hsinan Rd., Sec. 2, Wujih Dist., Taichung City, Taiwan 414

Tel: 886-4-2335-3299

Fax: 886-4-2335-6569

E-mail: fu.book@msa.hinet.net

Website: www.cens.com/fushen

CENS.com

Quick access to quality suppliers from Taiwan & China

2,000

inquires per day

product items online

300,000

global buyers have joined us

1,000,000

Sourcing suppliers?

We can help!

Contact CENS Buyer Service Team now,
and we'll get back to you within **48** hours

CENS 中經社

Taiwan sourcing service provider since 1974



LINESOON INDUSTRIAL CO., LTD.



AUTOMATIC TRANSMISSION PARES



DIAPHRAGM SPRING



RUBBER PISTON

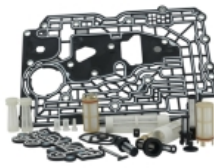

SCREEN FILTER

LINESOON INDUSTRIAL CO., LTD. is dedicated in Transmission System Parts, Clutch Plates, Clutch Facings, Transmission Components with operations in Taiwan

LINESOON INDUSTRIAL CO., LTD.

No. 466, Jhongshan Rd., Sigang Township,
Tainan County, Taiwan 723

Tel:886-6-796-1929

Fax:886-6-796-1932

E-mail: sales@linesoon.com.tw

Website: www.linesoon.com.tw

Transmission System Parts, Clutch Plates, Clutch Facings, Transmission Components



TRANSSION FILTER

SHANG HAO PRECISION TECHNOLOGY CO., LTD.

**Valves, Fastner, Auto Parts, Gear,
Axis, Hxdraulics and Plumbory
Products, Hardware Parts and
Lighting Parts, Bathroom**

Precision, Efficiency and Enthusiasm are our operation goals. In order to have long-run business in the worldwide market to overcome the economic downturn, all you need is to have a reliable manufacturer to supply high quality products and competitive price to you. Shang Hao can help you achieve these goals because we have the following advantages: Over 20 years of experience in industrial components. Best price and high quality. Punctual Deliver Professional skills, good quality, accurate delivery Shang Hao is a factory with a fine reputation. These 3 strong points allow us to become famous and reliable. All the customers and cooperation can count on us, for we will do our best to satisfy customers' requirements. Due to the strict self-discipline, Shang Hao has passed the ISO9001 certification. Despite the economic slump, precision, efficiency, ...

SHANG HAO PRECISION TECHNOLOGY CO., LTD.

No. 35-9 Fuxing Rd., Waipu Village, Fuxing Township,
Changhua County, Taiwan 50648

Tel:886-4-779-5599

Fax:886-4-779-5588

E-mail: shang.hao168@msa.hinet.net

Website: www.cens.com/shanghao



Connector parts



Connector parts



Hardware parts



Hardware parts



Suspension System Parts

A-ONE PARTS CO., LTD.	98
A-ONE PARTS CO., LTD.	99
BAO CHUAN INDUSTRIAL CO., LTD.	100
FONG SHUN MACHINERY CO., LTD.	101
FORSA ENTERPRISES CO., LTD.	102
NAN SHUN SPRING CO., LTD.	103
SHANG HAO PRECISION TECHNOLOGY CO., LTD.	104

A-ONE PARTS CO., LTD.

Center Bearing Support, Strut Mounting, Steering Gear Assy, Steering Coupling & Joint, Steering Couplings, Center Bearings Support

A-One Parts Co., Ltd. was building in 1989. "Where is the car, where is our parts" is not only our purpose but also our way. Our main production lists follow items:
CENTER BEARING SUPPORT ABSORBER
MOUNTING STEERING GEAR ASSY STEERING
COUPLING & JOINT The parts main exported for
United State, South East Asia and Austrilia. Secondary market is West Europe, Modia South America, South Africa and so on. Holding" Excellent Quality, Reasonable Price and Prompt Serving" is our goal, thoroughly carries out the symbol of perfect production so as to accept the arrival of international trade liberalization. Welcome your sample or drawing in advance, serving your is our pleasure.

A-ONE PARTS CO., LTD.

No. 10, Alley 13, Lane 228, Taihsi S. Rd., Lungching Dist.,
Taichung City, Taiwan 434

Tel:886-4-2639-3000, 2639-3719

Fax:886-4-2630-3277, 2630-3655

E-mail: aonepart@ms38.hinet.net

Website: www.a-oneparts.com



STRUT MOUNTING



STRUT MOUNTING



control arm



STRUT MOUNTING

A-ONE PARTS CO., LTD.

Center Bearing Support, Strut Mounting, Steering Gear Assy, Steering Coupling & Joint, Steering Couplings, Center Bearings Support

A-One Parts Co., Ltd. was building in 1989. "Where is the car, where is our parts" is not only our purpose but also our way. Our main production lists follow items:
CENTER BEARING SUPPORT ABSORBER
MOUNTING STEERING GEAR ASSY STEERING
COUPLING & JOINT The parts main exported for
United State, South East Asia and Austrilia. Secondary
market is West Europe, Modia South America, South
Africa and so on. Holding" Excellent Quality, Reasonable
Price and Prompt Serving" is our goal, thoroughly carries
out the symbol of perfect production so as to accept the
arrival of international trade liberalization. Welcome your
sample or drawing in advance, serving your is our
pleasure.

A-ONE PARTS CO., LTD.

No. 10, Alley 13, Lane 228, Taihsi S. Rd., Lungching Dist.,
Taichung City, Taiwan 434

Tel:886-4-2639-3000, 2639-3719

Fax:886-4-2630-3277, 2630-3655

E-mail: aonepart@ms38.hinet.net

Website: www.a-oneparts.com



CONTROL ARM



STRUT MOUNTING



STRUT MOUNTING



CENTER BEARING SUPPORT

BAO CHUAN INDUSTRIAL CO., LTD.

Shock Absorbers

BAO CHUAN INDUSTRIAL CO., LTD., located in TAIWAN has more than 18-year experiences in design, manufacturing and sales of automotive shock absorbers. Products the customers with the competitive products in quality, technology, service and price competitive products in quality, technology, service and price, which E-power the most value for its customers. E-power shock absorber has been recognized by its customers throughout the world. BAO CHUAN INDUSTRIAL CO., LTD., follows "Quality First" principle in everything we do throughout all the stages of product realization. Perfect product design, carefully selected raw materials, reliable production process, differentiated packaging makes E-power ...



Ahock Absorbers



Ahock Absorbers



Ahock Absorbers



Ahock Absorbers

BAO CHUAN INDUSTRIAL CO., LTD.

428 Chungcheng 2nd St., Yung kang, Tainan Hsien, Taiwan 710

Tel:886-6-254-5306

Fax:886-6-254-9590

E-mail: baochuan@ms87.url.com.tw

Website: www.cens.com/baochuan

FONG SHUN MACHINERY CO., LTD.

Auto Parts, Steel Tubes, Motor Casting

FONG SHUN MACHINERY CO., LTD. is dedicated in Auto Parts, Steel Tubes, Motor Casting, Steel tubes for Motorcycle parts, Steel tubes for Bicycle parts, Steel tubes for Shock absorber, Steel tubes for handtools with operations in Taiwan

FONG SHUN MACHINERY CO., LTD.

45-10 Hsialun, Miaolun Village, Hsikou Township, Chiayi County, Taiwan 62349

Tel:886-5-269-6229

Fax:886-5-269-6239

E-mail: service@fongshun.com

Website: www.fongshun.com



Stainless Steel Pipes & Tubes

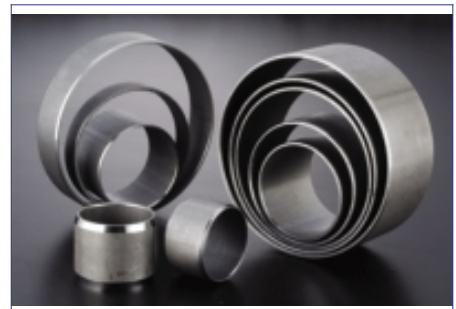

Stainless Steel Pipes & Tubes



Stainless Steel Pipes & Tubes



Stainless Steel Pipes & Tubes

FORSA ENTERPRISES CO., LTD.

Motorcycle Shock Absorbers in General, Cushions/Shock Absorbers (Front), Rear Shock Absorbers, Shock, Absorbers

Forsa Enterprises Co., Ltd., setting up on the 16th of August 1987, We have become a professional manufacturer specialized in of shock absorbers for motorcycles and special vehicles. Our products, despite being provided to major motorcycle assembly factories (O.E.M.) nationally and internationally, are exported to over 50 countries through trading companies. With the operation of our business based on the idea of honesty, trust, diligence, frugality, and the pursuit for perfection. We have always been improving ourselves constantly and developing new models at the lowest cost. We moved to our present extended factory on the 16th of December 1997 and added new inspecting instruments to ensure our products meeting our customer's needs, both in the quality and quantity. In 1998, a whole set of machinery for CNC production was added to our production lin ...

FORSA ENTERPRISES CO., LTD.

6 Jingchung Rd., Yungkang Industrial Park, Yungkang Dist., Tainan City, Taiwan 710

Tel:886-6-231-7577

Fax:886-6-203-0948

E-mail: forsa@ms48.hinet.net

Website: www.cens.com/forsa



Shock Absorbers



ATV Shock Absorbers



Shock Absorbers



Shock Absorbers

NAN SHUN SPRING CO., LTD.

Precision Spring, Iron Wire Products, Electronic parts, Spring, Furniture Hardware, Hardware, Electronic and Computer Products

Established in 1987, our company is specialized in precision spring with research and design. We keep the development of our products to suit our customers' special demands and constantly research new products to fulfill markets. Our services and products have won worldwide customers' trusts, and we believe it will be your best choice! Main Products : Our company produces finest quality products which included springs/ wire forming, flats, clips, clothes hangers, hooks, rings, clamps, metal hardware parts, CNC processing products, spring leafs/ sheets, stainless steel hardware, pins, wire form bending shapes and etc. we also accepting order to produce all types of parts according to customers , sample or drawing (auto cad or pro/e 3D files). Machine Processing Equipments: Cutter Machine / Sawing Machine Grinder Machine Precision Milling M ...



NAN SHUN SPRING CO., LTD.

No. 6, Alley 63, Lane 446, Changmei Rd., Sec. 2, Tiehshan Borough, Homei Town, Changhua County, Taiwan 50848

Tel:886-4-735-9685

Fax:886-4-735-1091

E-mail: nanshun@nanshun.com.tw

Website: www.nanshun.com.tw

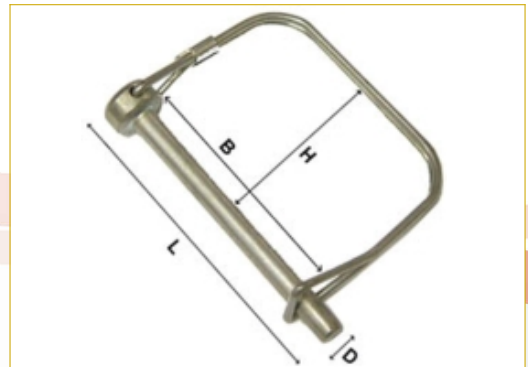

COUPLER LOCK PIN TYPE-2



Toothed Spring Pins / Powder Casing Spring Pins



Safety Pin Rings / Linch Pins / Lynch Pins



Shaft Lock Pin / Tube Clip / Linch Pin / Lynch Pin

SHANG HAO PRECISION TECHNOLOGY CO., LTD.

**Valves, Fastner, Auto Parts, Gear,
Axis, Hxdraulics and Plumbory
Products, Hardware Parts and
Lighting Parts, Bathroom**

Precision, Efficiency and Enthusiasm are our operation goals. In order to have long-run business in the worldwide market to overcome the economic downturn, all you need is to have a reliable manufacturer to supply high quality products and competitive price to you. Shang Hao can help you achieve these goals because we have the following advantages: Over 20 years of experience in industrial components. Best price and high quality. Punctual Deliver Professional skills, good quality, accurate delivery Shang Hao is a factory with a fine reputation. These 3 strong points allow us to become famous and reliable. All the customers and cooperation can count on us, for we will do our best to satisfy customers' requirements. Due to the strict self-discipline, Shang Hao has passed the ISO9001 certification. Despite the economic slump, precision, efficiency, ...

SHANG HAO PRECISION TECHNOLOGY CO., LTD.

No. 35-9 Fuxing Rd., Waipu Village, Fuxing Township,
Changhua County, Taiwan 50648

Tel:886-4-779-5599

Fax:886-4-779-5588

E-mail: shang.hao168@msa.hinet.net

Website: www.cens.com/shanghao



Connector parts



Connector parts



Hardware parts



Hardware parts



Brake System Parts

CHUMMY VEHICLE PARTS INC.	106
LIH DAH BRAKE LINING IND. CO., LTD.	107
LUH DAH BRAKE CORPORATION	108
LUH DAH BRAKE CORPORATION	109
LUNG MING LI CO., LTD.	110
PAN ASIA AUTOPARTS LIMITED	111
SAJONES CO., LTD.	112
SINDACO AUTOMOTIVE INDUSTRY CO., LTD.	113
SING YUNG MACHINERY CO., LTD.	114
TAIWAN BRAKE TECHNOLOGY CORP.	115

CHUMMY VEHICLE PARTS INC.

Brake System Parts, Control Cables, Brake Pipes, Hand Brake Cables, Wire Assemblies, Booster Cables, Special Cables

CVP Inc. was founded in Chang-Hua City in 1969. It was named "De-Sheng Wire Inc.," Employed only 30 personnel and manufactured bicycle cable in the beginning until year of 1973. Due to the increasing sales figures and limited spaces, the company decided to relocate its facility to the current address of No.135, sec 3, Jhongshan Rd. and rename the factory to be "Ho-Tian Industrial Ltd." With further productivity enhanced, the company added the automotive and motorcycle production lines for domestic and foreign sales. In 1980, product categories of cable and wire included a wide range of commercial equipment such as agricultural equipment of sprayer, grain combine, tractor and digger...etc.; snowmobile, marine boat, jet ski, land-mower, forklift, and air plane. The company was renamed as "CVP Inc." and added the assemble production line

CHUMMY VEHICLE PARTS INC.

133 Chungshan Rd., Sec. 3, Changhua, Taiwan 500

Tel:886-4-723-6197/9

Fax:886-4-725-1604

E-mail: cable@cvp.com.tw

Website: www.cvp.com.tw



Repair Tools



Motorcycle Control Cables



Wire Rope Making Machines



Auto Control Cables

LIH DAH BRAKE LINING IND. CO., LTD.

Disc Brake Pads, Brake Shoes, Brake Linings, Clutch Shoes

Lih Dah Brake Lining Industrial Co. has dedicated itself to making braking system parts for a variety of vehicles and machines ever since its inception as an export-driven Taiwanese manufacturer in 1973. A devotion to the sharpening of its competitive edge has helped Lih Dah to achieve sustainable growth over the past decades. To satisfy its demanding customers, the company has strived constantly to improve its manufacturing technologies and upgrade its production equipment. It has also placed strong emphasis on R&D, developing new friction materials including non-asbestos and low- and semi-metallic materials as well as exterior designs that enhance the added value of its products. Lih Dah also devotes unremitting efforts to improving quality, carrying out strict by-the-book quality-control measures at the factory, and constantly improving quality stan ...

LIH DAH BRAKE LINING IND. CO., LTD.

1 Hsinho Rd., Anping Ind. Dist., Tainan, Taiwan 708

Tel:886-6-265-3316, 265-4386

Fax:886-6-264-2853

E-mail: sok9001@yahoo.com.tw

Website: www.sok-brake.com



Auto Disc Brake Pads



Brake Shoes



Clutch Shoes



Brake Linings



LUH DAH BRAKE CORPORATION

Brake Pads & Brake Shoes & Brake Lining

ISO9001/ECE Certified



Professional Manufacturer & Exporter

No.16 Kaifa 4th Rd., Paoan Village, Rende Dist. Tainan City,71750 Taiwan

Tel: 886-6-2665236(Rep)

Fax: 886-6-2665238

e-mail: luhdah@ld-brake.com.tw

<http://www.ld-brake.com.tw>

LUH DAH BRAKE CORPORATION

Brake System, Steering System, Transmission System, Brake System Parts, Disc Brake Pads, Brake Shoes



Disc Brake Pads Brake Shoes & Linings

LUH DAH is one of the leading manufacturer brake pads and shoes in Taiwan for more than 30 years, We produce brake parts in our shop with experienced and highly trained employees. With over 30 years experience in the brake pads and shoes we have devoted many years of research and can also assemblies per your drawing to supply finished parts. Over 95% of our products are distributed through Asia, America, Europe, Australia and Africa. Our excellent scope of products and services, through continuous improvement and development, based upon our experience and technology, service a multitude of brake worldwide. We have three well known brand like LDB, HOKU and AILOTO for brake pads and shoes, fully backed by the ISO9002 & QS9000 & ECE MARK R90 certificate. We are proud of these advancements and are fully dedicated to developing new and better technology designed to make our products even ...

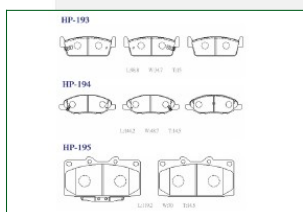

Disc Brake Pads

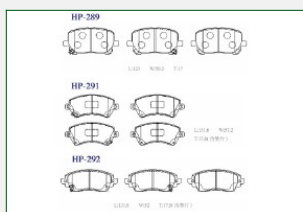

Disc Brake Pads, Brake Shoes, Brake Lining



Disc Brake Pads Brake Shoes & Linings



LUH DAH BRAKE CORPORATION

No. 16, Kaifa 4th Rd., Paoan Industrial Park, Jente Dist., Tainan City, Taiwan 717

Tel:886-6-266-5236

Fax:886-6-266-5238

E-mail: janice@ld-brake.com.tw

Website: www.ld-brake.com.tw

LUNG MING LI CO., LTD.

PTFE Steel-braided Brake Hose(with standard of TUV DOT SAE), Grease Gun Connecting Hose(Nylon), DOT Teflow Racing

Since 1999, we have been specializing in producing high quality brake hoses, power steering hoses, paintball gun hoses, coil hoses, high pressure & high-heat resistant air/oil/steam hoses and various fittings & adapters. Now we are one of the leading manufacturers in Taiwan and Asia. Our PTFE (Teflon) stainless steel-braided BRAKE HOSE have been certified by the standards of US DOT FMVSS 106, SAE J1401, ADR 7/00, TSD 106, GB 16897, and JIS D 2601: 2006 (JSAE/JSA). We not only provide the best quality, the most competitive price, and high efficiency, but also have the ability to satisfy all your customization requests. Company: LUNG MING LI CO., LTD. Address: Bldg. C, No. 30, Alley 689, Lane 18, Hsinan Rd., Sec. 1, Wujih Dist., Taichung City, Taiwan 414 TEL: 886-4-2335-9090 FAX: 886 ...



LUNG MING LI CO., LTD.

Bldg. C, No.30, Alley 689, Lane 18, Sec.1, Hsinan Rd., Wujih Dist., Taichung City, Taiwan 41462

Tel:886-4-2335-9090

Fax:886-4-2335-9191

E-mail: lomili.1@lml-hose.com.tw

Website: www.lml-hose.com.tw



Brake Hoses



1/8" PTFE Stainless Steel Braided Brake
Hose



Joint



4000 series Fixed Banjo

PAN ASIA AUTOPARTS LIMITED

Door Window Regulator, Door Handle, Door Hinge, Door Window Regulator Motor, Brake Parts, Clutch Parts

PAN ASIA AUTOPARTS LIMITED is dedicated in Door Window Regulator, Door Handle, Door Hinge, Door Window Regulator Motor, Brake Parts, Clutch Parts, Brake Master, Wheel Cylinder, Window Regulators, Door Handles, Auto Parts, Body Parts with operations in Taiwan



GM chevrolet Window Regulator



TFR PICKUP



Mazda-B2200 Window Regulator

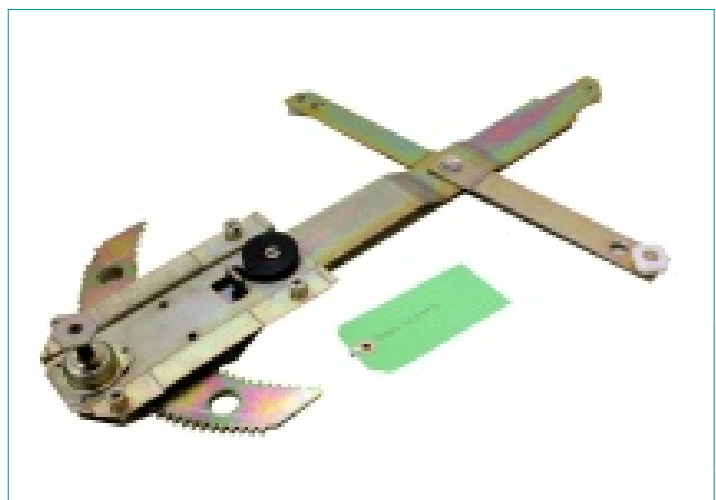

Land Rover Window Regulator BHL105673

PAN ASIA AUTOPARTS LIMITED

246 Dachu Rd., Luchu Township, Taoyuan County, Taiwan 338

Tel:886-3-323-4711/4

Fax:886-3-323-4715

E-mail: panautos@ms26.hinet.net

Website: m.cens.com/s/22359831

SAJONES CO., LTD.

Distributors & Components, Ignition Systems

We have stuck to our core management concept of "Customers First, Service First" since our company was established in 1970. With a strong research and development team, we can offer diverse products to meet customers' requirements. Our major products are brake master cylinder, wheel cylinder, clutch slave cylinder and clutch master cylinder and other automobiles parts. We have conducted the strictest quality control to pursue perfect quality. As a TS16949 certified brake cylinder manufacture, we are confident not only in our quality but also the excellent services that we can deliver to our customers. We strongly believe that we can become your best partner on a long-term basis. Please contact us if you need more information.

SAJONES CO., LTD.

6th Fl., 5 Tunhua S. Rd., Sec. 2, Taipei, Taiwan 10681

Tel:886-2-2700-9301

Fax:886-2-2704-7987, 2325-2109

E-mail: sajones@ms9.hinet.net

Website: www.sajones.com



BRAKE MASTER CYLINDER



IGNITION Distributor



IGNITION Distributor



Brake Master Cylinder

SINDACO AUTOMOTIVE INDUSTRY CO., LTD.

**Clutch Boosters, Air Masters, Foot
Valves, Relay Valves, Air
Governors, Air Dryers, Cartridge
Assemblies, Repair Kits, Clutch**

"SDC" is a reliable manufacturer and the best brand in Taiwan, specializing in making the Japanese Truck & Trailer Parts - Clutch Booster, Foot Valve, Airmaster, Relay Valve, Pressure Regulator, Brake Chamber.....and much more. We have over twenty years (since 1987) of Technical Experience in these production lines. We have a reputable and professional sales force covering the local and export markets with our strict QC control. Our mission is to provide best quality and best service to our valuable customers.

SINDACO AUTOMOTIVE INDUSTRY CO., LTD.

233 Kuosheng St., Yungkang Dist., Tainan City, Taiwan 710

Tel:886-6-253-0731

Fax:886-6-253-8609

E-mail: sindaco.auto@msa.hinet.net

Website: www.sindaco.com.tw



Clutch booster Assy & Repair Kits



Air Brake Assy & Repair Kits



Airmaster Assy & Repair Kits



Pressure Regulator & the Others

SING YUNG MACHINERY CO., LTD.

Hydraulic Brake & Clutch Parts, Repair Kits, Rubber Parts, Brake Master Cylinder Assemblies

SING YUNG MACHINERY CO., LTD. is dedicated in Hydraulic Brake & Clutch Parts, Repair Kits, Rubber Parts, Brake Master Cylinder Assemblies, Special-Purpose Vehicles, Clutch Master Cylinder Assemblies, Clutch Operating Cylinders, Clutch Slave Cylinders, Automobile Brake Systems, Forklifts, Brake Wheel Cylinders, Brake System Parts, Hydraulic Brake Parts, Auto Parts, Brake Parts, Hydraulic Clutch Parts, Special-Purpose Vehicle Parts with operations in Taiwan

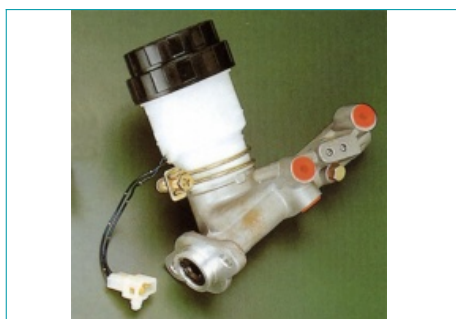

Hydraulic Brake



Hydraulic Brake



Hydraulic Brake



Hydraulic Brake

SING YUNG MACHINERY CO., LTD.

3 Kungyeh 3rd Rd., Touchiao Industrial Dist., Minhsiung Townshi, Chiayi County,
Taiwan 621

Tel:886-5-221-1211

Fax:886-5-221-8217, 220-1110

E-mail: symc@ms41.hinet.net

Website: m.cens.com/s/04474599



Brake Pads

TAIWAN BRAKE TECHNOLOGY CORP.

Tel:886-6-593-3800
Fax:886-6-593-3528
E-mail: tbt@taiwanbrake.com
Website:
www.cens.com/taiwanbrake

With nearly 20 years of experience in the friction aftermarket, TBT is a professional manufacturer and well recognized supplier of automotive brake friction products, specializing in Brake Pads & Shoes. Our products are exported throughout the world and we continue to expand in the automotive trading market. During the past decade, we have strived with the best effort to transform our company from a traditio ...



Brake Pads



Brake Pads



Brake Pads

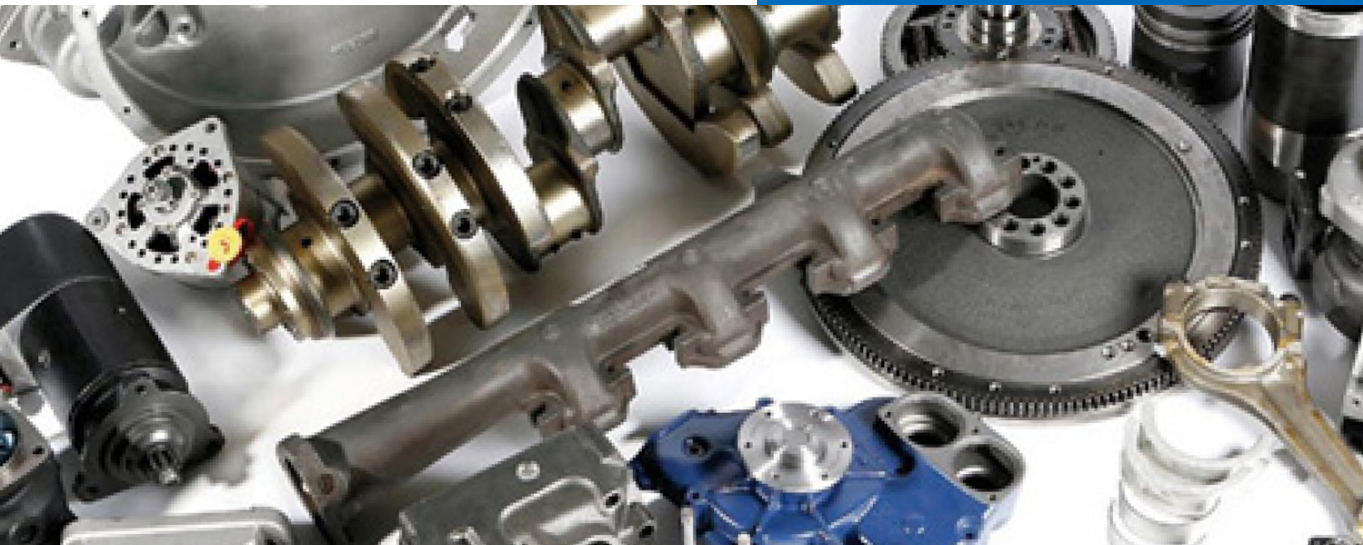

Chassis Parts

JUIN DAW ENTERPRISE CO., LTD.

117

MAIN HORN INDUSTRIAL CO., LTD.

118

JUIN DAW ENTERPRISE CO., LTD.

Sending Unit, Fuel Gauge, Fuel Level Sensor

Juin Daw Enterprise Co., Ltd. have had more than 20 years of experience in manufacturing Sending unit(fuel gauge / fuel level sensor) and have ISO 9001 certificated. In the beginning we only designed for Japanese cars, later we also developed models for U.S. cars as well as European and American classic cars, which have since become our major products. Selling over a thousand kinds to the U.S., Canada, Central and South America, Africa, the Middle East, New Zealand, Australia, and Southeast Asia, we now also supply innovative sending unit assemblies used on heavy-duty vehicles and boat. Look forward to setting up the business relationship with you very soon.



JUIN DAW ENTERPRISE CO., LTD.

2nd Fl., No. 8, Chungshin Rd., Sec. 1, Wugu Dist., New Taipei City, Taiwan 248

Tel:886-2-8976-9162

Fax:886-2-8976-9160

E-mail: juindaw@gmail.com

Website: www.jdlmt.com



SENDING UNIT/FUEL GAUGE/FUEL LEVEL SENSOR

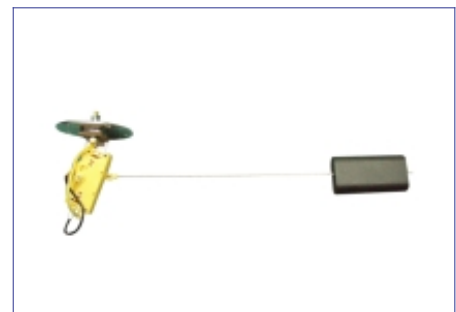

Sending Unit/Fuel Gauge/Fuel Level Sensor

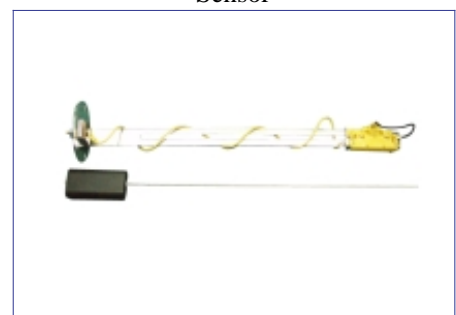

Sending Unit/Fuel Gauge/Fuel Level Sensor



SENDING UNIT/FUEL GAUGE/FUEL LEVEL SENSOR

MAIN HORN INDUSTRIAL CO., LTD.

**Suspension System, Tie Rod End,
Sway Bar Link, Drag Link, Rod
End, Idler Arm, Pitman Arm,
Directional machine connector**

KTC (Main Horn Industrial Co., Ltd) established on 1959. We are one of the professional manufacturers of steering part in Taiwan. We provide suspension parts and steering system, like ball joint, tie rod end, control arm, idler arm, center link, rack end and sway bar. Our products and toolings which the whole steps and processes of production, including assembly, packing and shipping arrangement, all are done in Taiwan.



Control arm

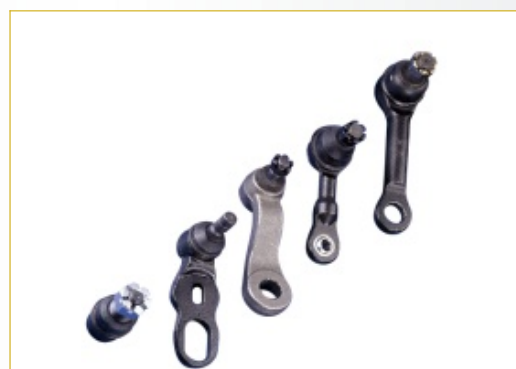

Ball joint



Drag link



Tie rod end



MAIN HORN INDUSTRIAL CO., LTD.

211-3 Sanhsi Rd., Sec. 1, Hsiting Village, Tienwai Township,
Changhua County, Taiwan 522

Tel: 886-4-883-3707

Fax: 886-4-883-1468

E-mail: main.horn@msa.hinet.net

Website: www.ktc-mainhorn.com.tw



Body Parts

HENG FU INDUSTRIAL CO., LTD.	120
HUNYO CO., LTD.	121
AUTO PARTS INDUSTRIAL LTD.	122
CAR FULL ENTERPRISE CO., LTD.	123
CHIN HUNG INDUSTRIAL CO., LTD.	124
KDC AUTO INDUSTRY CO., LTD.	125

HENG FU INDUSTRIAL CO., LTD.

Bumper, Grille, Fender, Grille Panel, Rocker Panel

Heng Fu has established distribution network all over the world, which helps us to better promote our products in the international market, owing to our punctual delivery, competitive price and diversified production line, now we have successfully obtained more than 50% market share and received customers' support and trust widely, but we will carry out continuous research and development, establish our technical standard, improve the efficiency of the processing to provide customers with superior products and services. Our glory comes from your appreciation, how to maintain and create a more glorious, brilliant future, is our most important responsibility.

HENG FU INDUSTRIAL CO., LTD.

36-3 Chichiao, Chiting Li, Chunan Town, Miaoli County, Taiwan 350

Tel:886-37-583-629

Fax:886-37-583-361

E-mail: export@bumpers.com.tw

Website: www.bumpers.com.tw



Grilles



Bumper



Grilles



Bumper

HUNYO CO., LTD.

Power Window Motors

Established in 1986, Hunyo Co., Ltd. has been dedicated to developing and manufacturing high-quality and -precision reduction-gear motors for various applications, including automotive power windows. Thanks to their outstanding quality, functionality and durability, Hunyo`s motor products have been popular with global customers. Currently, Hunyo exports motors to major markets such as Japan, Australia, the U.K., Germany and other European nations. Sales in these markets have been enjoying stable growth. Hunyo claims that its high-level reduction gear motors feature many advantages, including high torque, low current, short operation time, narrow space, waterproof, and low noise. To meet special requirements, the waterproof grade of Hunyo`s motors has reached IP66. The company has developed products for Scania (112/113), Volvo (FL10), MAN, ...

HUNYO CO., LTD.

No. 66, Kong Erh Rd., Long Tan Township, Taoyuan County, Taiwan 325

Tel:886-3-480-0379

Fax:886-3-480-0381

E-mail: wilsontsai@ms94.url.com.tw

Website: www.hunyo.com.tw



Isuzu NPR/NQR/NKR Window Motor FR



Mercedes Benz Actros Window Motor FR

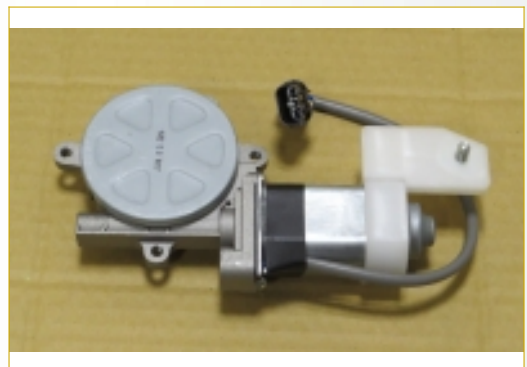

ISUZU 10PC1 Truck Window Motor FR



FUSO power window motor

AUTO PARTS INDUSTRIAL LTD.

Auto Body Parts, Brake Parts, Steering Parts

Founded in 1979, AP, through its strategic planning, dedication to quality, innovation and persistence, has become a major player in the global auto replacement parts industry. AP's commitment to quality is deeply rooted in its people's desire to provide excellent customer service. Every aspect of manufacturing and sales achievements is built on intelligent systems, engineering and teamwork. AP, operating with the strictest quality controls & production management, is accredited by CAPA & Europe's, Thatcham. The largest selection of multiple product lines and certified application's has made AP the most recognizable Global supplier offering a "One-Stop" Shopping Experience. Our 3B-Bumper program features: Better

AUTO PARTS INDUSTRIAL LTD.

No. 456, Kuolin Li, Kuolin Rd., Sec. 2, Chungli City, Taoyuan County, Taiwan 320

Tel:886-3-420-1919 (Rep.)

Fax:886-3-420-1177

E-mail: service@autoparts.com.tw

Website: www.autoparts.com.tw



Mechanical Parts: Suspension, Steering, Hub Bearing



Sheet Metals: Hoods, Fenders, Door Shells & Assemblies, Radiator, Handle



Electrical Parts :Power Regulator, Compressor, Distributor, Wiper Motor.



Cooling Systems: Cooling Fan Assemblies, Radiators, Condensers,

CAR FULL ENTERPRISE CO., LTD.

Body Parts, Mirrors, Lamps Series, Auto Parts, Lamps, Suspension System, Cooling System Parts, Hoods, Head Lamps, Grille & Rear Guards

We have been in the business of auto-body parts manufacturing and exporting since 1987. We specialize in manufacturing a wide array of auto-use bumpers, grilles, hoods, fenders, lamps, and mirrors. To provide our customers with the best possible service, we not only provide in-house-manufactured products, but also provide other auto parts like chassis parts and electrical parts for engine and body systems. Apart from selling finished products, we also fill OEM/ODM orders and engage in export cooperation ventures with firms from foreign countries for developing molds. Recen ...



Suspension & Chassic Parts

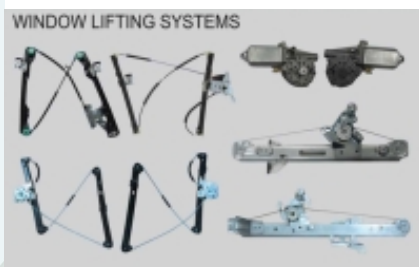

Window Lifting Systems



Interior Patts + Electronic Systems



Cooling Systems + Brake Parts

CAR FULL ENTERPRISE CO., LTD.

3rd Fl., No. 6, Lane 69, Sungchiang Rd., Taipei, Taiwan 104

Tel:886-2-2507-4749

Fax:886-2-2507-9848

E-mail: carfull.link@gmail.com

Website: www.carfull.com.tw

CHIN HUNG INDUSTRIAL CO., LTD.

Bumpers, Plastic Auto Parts

OEM PLASTIC AUTO PARTS. OEM INTERIOR IRON FASTENERS OFR BUMPERS.

CHIN HUNG INDUSTRIAL CO., LTD.

No. 334, Changnan Rd., Sec. 3, Changhua, Taiwan 500

Tel:886-4-738-4836

Fax:886-4-738-4499

E-mail: clip.world@msa.hinet.net

Website: m.cens.com/s/28050944



Bumper Bracket



Bumper Bracket



Toyota Hllux Vigo Bumper Bracket (LH)



Bumper Bracket

KDC AUTO INDUSTRY CO., LTD.

Auto Mirror, Special Auto Parts, Mirrors, Auto Parts, Lights, Lamps, Body Parts, Accessories, Panels, Grilles, Trailers, Tools

KDC AUTO INDUSTRY CO., LTD. is dedicated in Auto Mirror, Special Auto Parts, Mirrors, Auto Parts, Lights, Lamps, Body Parts, Accessories, Panels, Grilles, Trailers, Tools, Engine Parts, Electric Parts, Racing. Performance Parts, Fan Belts, Body Systems, Lid Clusters, Radiator Cooling Fan, Radiator Grille, Window Regulator, Grille, Side Mildg Set, Door Mirror, Signal Lamp with operations in Taiwan

KDC AUTO INDUSTRY CO., LTD.

No. 116, Zhongnan 6th St., Yongkang Dist., Tainan City, Taiwan 710

Tel:886-6-253-9099

Fax:886-6-253-8035

E-mail: kdcaloa@yahoo.com.tw

Website: m.cens.com/s/13079887

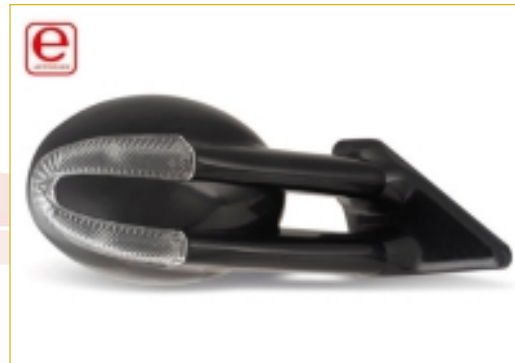

Racing Mirror (8pcs LED LIGHT)

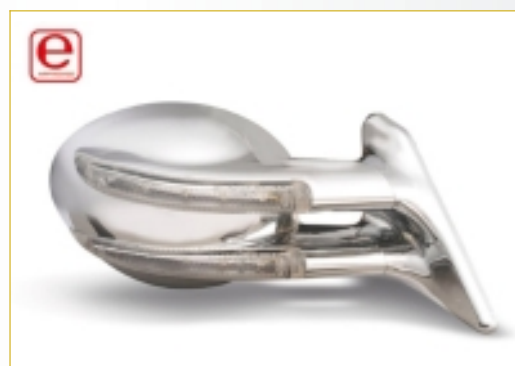

Racing Mirror (10pcs LED LIGHT)



TOWING MIRROR (UNIVERSAL TYPE)



TOWING MIRROR (UNIVERSAL TYPE)



Wheels, Tires, Wheel Covers

GOODTIME RUBBER CO., LTD.

127

GOODTIME RUBBER CO., LTD.

Tire, Tube, Rubber, Veloce, Goodtime, Scooter Tire, Motorcycle Tube, Tires, Implement Tires, Trailer Tires, Minivan Tires

Our office is in Taiwan and the tire factory is located in Vietnam. Our main products include ATV Tires, Solid Air Tires, Lawn Mower & Garden Tires, Wheel Barrow Tires, Implement Tires, Trailer Tires, Mini Passenger Car Tyres, Light Truck Tires, Snow Hog Tire, Agricultural Tractor Tires, Standard Street Motorcycle Tires, Scooter Tires, Hi-speed Tire, Tok-Tok Tires, and all kinds of Inner Tubes. We provide the competitive price, fast delivery, and the most important - best quality. Welcome to contact with us for further information.



Trailer Tires



Implement Tires



Wheelbarrow Tires



Lawn Mower & Garden Tires

GOODTIME RUBBER CO., LTD.

5F, No.86, Yongchang St., Yuanlin City, Changhua City 510,
Taiwan

Tel:886-4-832-2568

Fax:886-4-833-1186

E-mail: sales@mail.goodtimegroup.com.tw

Website: www.goodtimegroup.com.tw

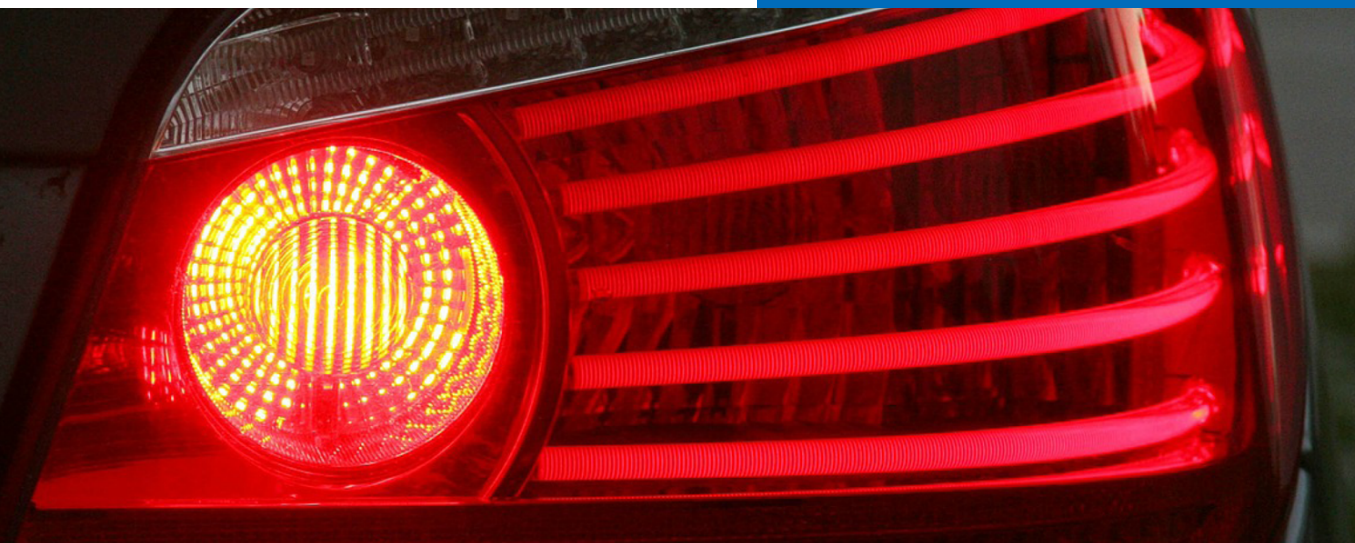

Lamps

EAGLE EYES TRAFFIC INDUSTRIAL CO., LTD.	129
HUA SHENG AUTOMOTIVE LTD.	130
YU CHUNG CHI ENTERPRISE CO., LTD.	131
AUTOPAX SUPPLIES, LTD.	132
CHING MARS CORPORATION	133
ESUSE AUTO PARTS MFG. CO., LTD.	134
GIANTLIGHT TRAFFIC SUPPLIES INSTRUMENT CO., LTD.	135
HWA LI INDUSTRIAL CO., LTD.	136
KELAI ENTERPRISE CO., LTD.	137
UNIQUE LITE INDUSTRY CO., LTD.	138
YU CHUNG CHI ENTERPRISE CO., LTD.	139

EAGLE EYES TRAFFIC INDUSTRIAL CO., LTD.

Auto Lamps, Head Lamps, Tail Lamps, Signal Lamps, Fog Lamps, Third Brake Lights, Rear Lamp, Corner Lamp, Side Lamp, Bumper

Eagle Eyes Traffic Ind. Co., Ltd. was established in 1978, company focus on develop vehicle lights, we both service replacement and performance lights, In order to provide more products to more customers, we also involved in heavy truck market. Please browse our website if you need any help

EAGLE EYES TRAFFIC INDUSTRIAL CO., LTD.

No. 27, Lane 764, Chung Shan N. Rd., Yung Kang Dist., Tainan City, Taiwan 71041

Tel:886-6-233-6618

Fax:886-6-233-1522, 201-3413

E-mail: sales@eagleeyes.com.tw

Website: www.eagleeyes.com.tw



Tail Lamps



Auto Lamp



Auto Lamp



)Auto Lamp

HUA SHENG AUTOMOTIVE LTD.

Head Lamps, Tail Lamps, Signal Lamps, Fog Lamps, Third Brake Lights, Warning Lights, 360 Eagle View, Electronic

1.About Hua-Sheng HUA-SHENG auto parts focuses on market-trend designs, and strives to offers efficient, quality and professional services to our customers. Other than carrying domestic and imported headlights and other premium quality auto parts and products, we can also offer OEM and ODM services. Our corporate mission is to provide the best products and services to our customers under the most stringent quality control and to achieve win-win situation with our customers and suppliers.

2.Competitive Advantage Our competitive advantage, other than obtaining the ...



12V 20AH Lithium Iron Phosphate Car Automotive



Jeep Wrangler 2007-2016 LED Head



TOYOTA GT86/SCION FR-S/SUBARU BRZ 2012-2016 LED DRL Side Repeater Marker Light Lamp

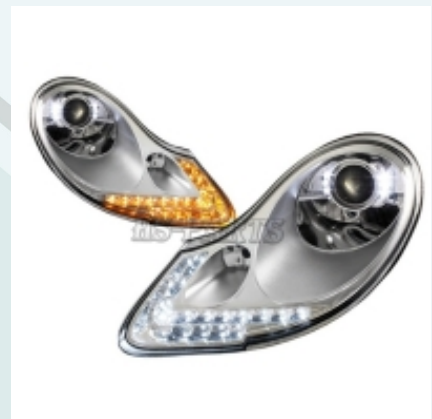

97-04 Porsche 996 LED Porjector



HUA SHENG AUTOMOTIVE LTD.

No.28, Ln. 36, Sec. 2, Anhe Rd., Annan Dist., Tainan City 709, Taiwan

Tel:886-6-3565737

Fax:886-6-3565760

E-mail: service@hs-parts.com

Website: www.cens.com/hua-sheng

YU CHUNG CHI ENTERPRISE CO., LTD.

**Car-use Photocatalytic Air Cleaner,
Truck Taillight, Taillight, Flush
Mount, Stoplight, Turn Light,
Clearance Marker Light**

As an expert of over 30 years in the arena, we are professionals in producing auto/motorcycle parts for international markets. Supported by our profound experience, excellent technique, we emerged as a specialist manufacturer for motorcycle engine valves and then are growing by R&D of various car lamps and mold designing. Currently, we're devoted to producing assorted side lamps, tail lamps, interior lamp, signal lamps, license lamps for trucks, lorries, tractor-trailers, vans and buses, apart from existing motorcycle rotary valves, and reed valves. We pay much attention to details of every process of our products, turn in the products on time, and are loyal to our customers and keen on meeting their demands. Each item exquisitely made by us are through strict QC system.



Tail Lamp



Truck Tail Lamp



Tail Lamp



Marker light

YU CHUNG CHI ENTERPRISE CO., LTD.

No. 40, Alley 85, Lane 533, Anho Rd., Sec. 4, Tainan,
Taiwan 709

Tel: 886-6-245-1155, 256-8379

Fax: 886-6-246-1176

E-mail: chiuym@ms55.hinet.net

Website: www.cens.com/yuchungchi

AUTOPAX SUPPLIES, LTD.

Door Mirror, LED Flashing Module, Electrical Parts, Mirrors

Enjoying preferred-buyer status with over 200 different suppliers, we can help you find and purchase just about any auto accessory you need. You can order our Car & Art or Type X House brands, or send us your OEM/ODM specifications for custom items. Either way, we'll consolidate your orders into one shipment, and send the whole lot to you in 30 days or less. Much easier than, say, calling and ordering from 10 different suppliers, and then receiving 10 different shipments on different days, and paying shipping on 10 different orders.

AUTOPAX SUPPLIES, LTD.

2nd Fl., No. 210, Hsintaiwu Rd., Sec. 1, Hsichih Dist., New Taipei City, Taiwan 221

Tel:886-2-2648-8220

Fax:886-2-2647-5876

E-mail: autopax.taiwan@msa.hinet.net

Website: www.autopax.com



Super Bright LED lights

Super Bright LED lights



Dual color side-view Strip 36LEDs
12VDC



Control Switch Panel with Lighted Push Button

Control Switch Panel with Lighted Push Button



A44008 2" x 1 1/2" Tachometer
Stripper meter movement
Digital display of rpm, C/W, W/T
Lens: Chrome or smoke

A44010 2" Tachometer
Stripper meter movement
Lens: Chrome or smoke

A44012 2 3/4" x 1 1/2" Tachometer
Stripper meter movement
Digital display of rpm, C/W, W/T
Lens: Chrome or smoke

Tachometer

CHING MARS CORPORATION

Warning Lights, Light Bars, Lamps, Police Light Bar, Strobe Light, Revolving Light, Plastic & Rubber Parts, Auto Accessories, Diversified Lighting

Ching Mars Corporation has been a strong force in the manufacture business of safety and warning lights for over 25 years. This Taiwan-based company supplies lights to many satisfied companies all over the world. With strong customer support & quality products, Ching Mars has developed into one of the most reliable suppliers for clients around the world. "Our principle is to produce high quality products and provide the best service to our customers".

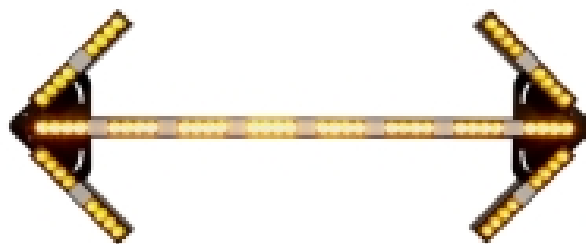

LOW PROFILE LED BAR LAMP



LED MODULE



MAGNET LED ROTATING/STROBE
LIGHT



LED STROBE LIGHT

CHING MARS CORPORATION

10th Fl., 502 Ta-an Rd., Shulin Dist., New Taipei City, Taiwan 238

Tel:886-2-8687-3877

Fax:886-2-8687-3833

E-mail: sales@chingmars.com.tw

Website: www.chingmars.com.tw

ESUSE AUTO PARTS MFG. CO., LTD.

Lamp, Accessories, Fog Lamps, Daytime Running Lights

ESUSE Auto Parts is a professional automotive lighting manufacturer in Taiwan. We established in 1984, with more than 20 years experience that we provide total solution for all lighting products, such as photometrical design, mould making, and laser scanning, CAD, rapid prototype, certification then into production. Our main products are Head lights, Tail lights, Signal lights, LED daytime running lights, LED fog lights, Fog lights/ Driving/ Spot lights, off-road lights, Lighting accessories, Switch, Wire kit.

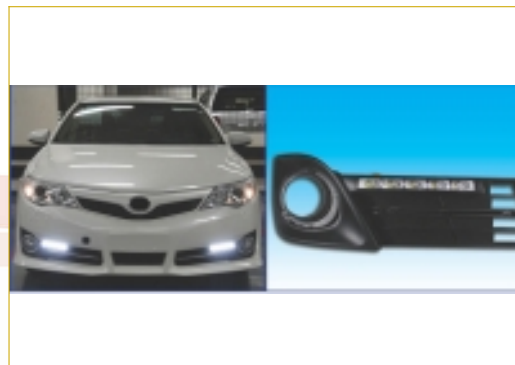

Daytime Running Lights

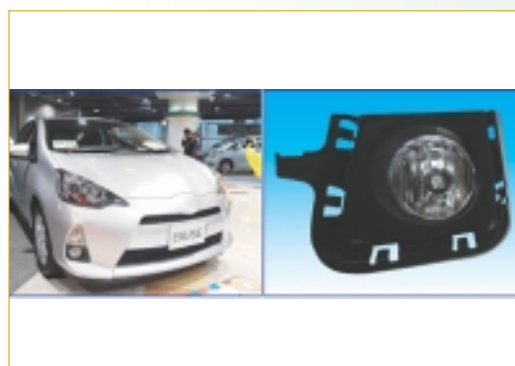

Fog Lamp

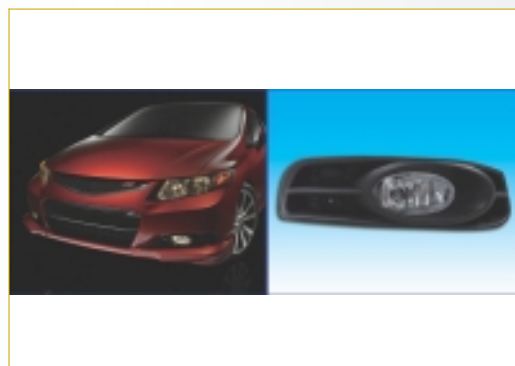

Fog Lamp

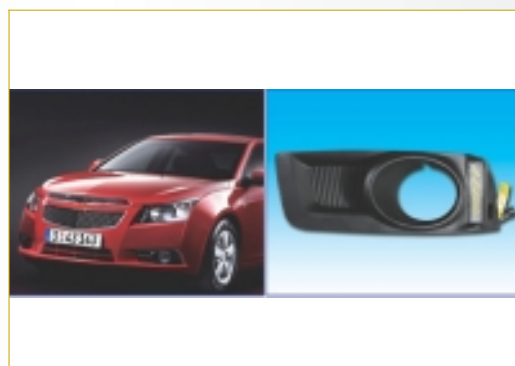

Daytime Running Lights



ESUSE AUTO PARTS MFG. CO., LTD.

No. 261, Fenliu Rd., Sec. 2, Linkou Dist., New Taipei Ciy, Taiwan 244

Tel:886-2-2603-2788#15

Fax:886-2-2603-2789

E-mail: sales@esuse.com.tw

Website: www.esuse.com.tw

GIANTLIGHT TRAFFIC SUPPLIES INSTRUMENT CO.,

Car Accessories: Head Lamps, Fog Lamps, License Lights, Circular Flashers, Galaxy Control Poles, Car Accessories, Head Lamps

Founded in 1977, GIANTLIGHT has been designing and innovating customized lighting systems of automotive and motorcycle for more than 35 years. Our Advantage: - With complete facilities of in-house and production equipment, we are proud of offering every headlamp to match customer requirement with excellent quality and price. - Close cooperation with qualified distributors over the world, which enables us to respond quickly and flexibly to our customers' needs at all times. - Professional and experienced R&D team can handle any OEM or ODM projects, no matter in photometric design, material selection, supplier quality control and quality certificate and test. Now we have passed and got several quality certificate as following, •ISO 9001:2000, TS 16949 QC is made under ISO 9001 and TS16949 regulations strictly. Guarantee you the best ...



**GIANTLIGHT TRAFFIC SUPPLIES
INSTRUMENT CO., LTD.**

No. 370, Pengyi Rd., Taiping Dist, Taichung City, Taiwan
411

Tel:886-4-2275-5678

Fax:886-4-2277-0565

E-mail: sales@giantlight.com.tw

Website: www.cens.com/giantlight



7" Bi-LED headlamp



LED Auto lamp 90mm low Beam LED
module DOT



LED Auto lamp 90mm high Beam LED
module E-mark



LED Auto lamp 90mm high Beam LED
module DOT

HWA LI INDUSTRIAL CO., LTD.

Head Lamps, Tail Lamps, Signal Lamps, Dies and Molds

Set up in 1986 as a mold engraver, Hwa Li Industrial soon in 1991 took critical steps to achieve automation to meet high-tech trends and enhance competitiveness, including purchasing automated machinery, adopting advanced design software and intensive staff training. With ample experience in mold-engraving, which significantly helps better our expertise in tooling, we diversified into building automotive lamps in 2003, offering integrated, in-house R&D, design, fabrication and packaging. Prioritizing safety and aesthetics, we offer quality, stylish items to suit various vehicles, as well as fast, all-round service and adhere to stringent QC. Customer satisfaction is always top priority. Ask us about lamps for any make and model. Custom/ ...

HWA LI INDUSTRIAL CO., LTD.

No.87-12, Nabalin, Xinhua Dist., Tainan City 712, Taiwan

Tel:886-6-591-2123

Fax:886-6-591-1567

E-mail: d1206345@ms48.hinet.net

Website: www.hwali.com



Taillight fOR Toyota Camry '12-on Taillight-W/LED



LED Taillight for Chevy
Trailblazer02-06'



Taillight for Kia Sportage '11-12-

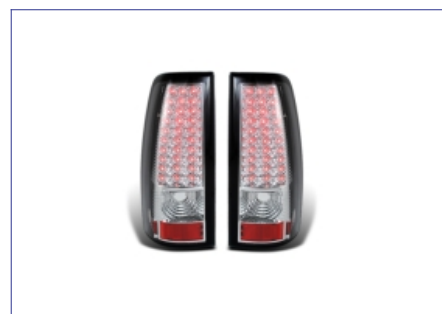

LED Taillight for CV Silverdo 03-06'

KELAI ENTERPRISE CO., LTD.

Auto Parts, Body Parts, Cooling Fan, Tie Rod End, Ball Joint, Cross Rod, Piston/Liner, Lamps, Pitman Arm

Kelai is a professional manufacturer and exporter of automotive replacement parts and accessories. We producing OEM and performance items, including of head lamp, tail lamp corner lamp and bumper, grille ,mirroretc. Our team has more than 20 years experience in th field, Kelai with the ability to offer customers with good advice and suggestions on purchase, the best product, quality , competitive price, and fast delivery. Also welcomes the opportunity to help new products with customers.



CAMRY HEAD LAMP

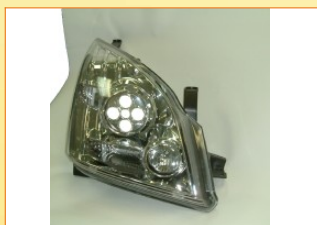

FJ120 HEAD LAMP



E38 HEAD LAMP

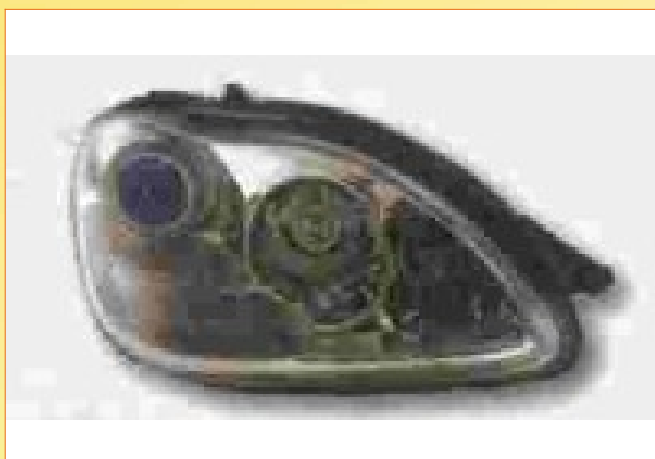

W220 HEAD LAMP

KELAI ENTERPRISE CO., LTD.

Rm. 4G24, No. 5, Hsinyi Rd., Sec. 5, Taipei City, Taiwan
110

Tel:886-2-2723-0155

Fax:886-2-2729-1150

E-mail: kelai.auto@msa.hinet.net

Website: www.kelai.com.tw

UNIQUE LITE INDUSTRY CO., LTD.

**Revolving Warning Light, Electronic Amplifier Siren,
Strobe Light, Police Light Bar, Traffic Baton**



MULTI-VOLTAGE STROBE LIGHTS



HIGH-
PERFORMANCE



HIGH POWER LED
WARRING LIGHT



HIGH-PERFORMANCE STROBE
LIGHTS

We, Unique Lite Industry Co., Ltd. are a professional manufacturer of warning light in Taiwan. Though the company was founded in 1996, our leader has more than twenty years experience in the warning light business in the field. We have successfully developed and supply our customers with a variety of warning light including multi-voltage strobe light, led strobe light, high power led light, mini led light bar, mini rotating light bar, revolving beacon, and backup alarm as of today. We hold a global supply chain for our customers in the world. We are committed to offering our customers with the best services. Our efficient production line also assures our customers of punctual and prompt shipment as well as consistent quality of our products. With full cooperation of teamwork, we prove ourselves to be trustworthy supplier to our customers. Despite the fact that our customers are widely spread all over the world, w ...

SIFCO

UNIQUE LITE INDUSTRY CO., LTD.

3rd Fl., 369 Chungsan Rd., Sec. 2, Chungho Dist., New Taipei City, Taiwan 235

Tel:886-2-2225-3438

Fax:886-2-2225-3440

E-mail: simon@uniquelite.com.tw

Website: www.uniquelite.com.tw

YU CHUNG CHI ENTERPRISE CO., LTD.

**Car-use Photocatalytic Air Cleaner,
Truck Taillight, Taillight, Flush
Mount, Stoplight, Turn Light,
Clearance Marker Light**

As an expert of over 30 years in the arena, we are professionals in producing auto/motorcycle parts for international markets. Supported by our profound experience, excellent technique, we emerged as a specialist manufacturer for motorcycle engine valves and then are growing by R&D of various car lamps and mold designing. Currently, we're devoted to producing assorted side lamps, tail lamps, interior lamp, signal lamps, license lamps for trucks, lorries, tractor-trailers, vans and buses, apart from existing motorcycle rotary valves, and reed valves. We pay much attention to details of every process of our products, turn in the products on time, and are loyal to our customers and keen on meeting their demands. Each item exquisitely made by us are through strict QC system.



Tail Lamp



Truck Tail Lamp



Tail Lamp



Marker light

YU CHUNG CHI ENTERPRISE CO., LTD.

No. 40, Alley 85, Lane 533, Anho Rd., Sec. 4, Tainan,
Taiwan 709

Tel: 886-6-245-1155, 256-8379

Fax: 886-6-246-1176

E-mail: chiuym@ms55.hinet.net

Website: www.cens.com/yuchungchi

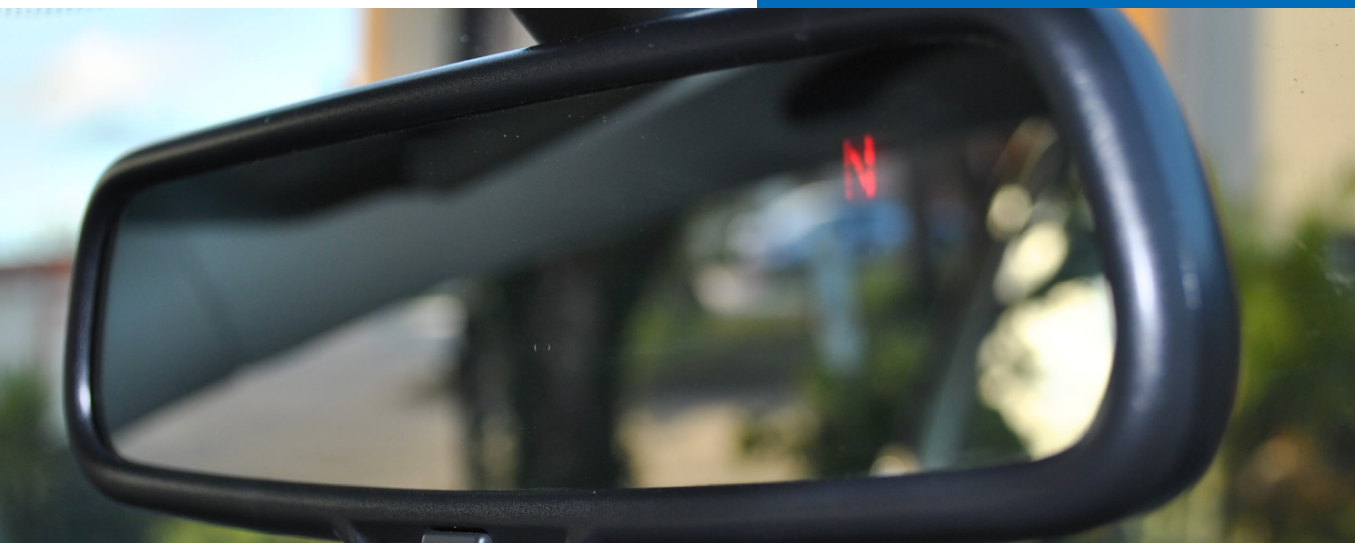

Mirrors

TKS INDUSTRIAL CO.,LTD.	141
TZY KING ENTERPRISE CO., LTD.	142
VIEW MAX INDUSTRIAL CO., LTD.	143
YONG SHENG CO., LTD.	144

TKS INDUSTRIAL CO.,LTD.

Car Mirrors, Automotive Mirrors, Exterior Accessories

TKS INDUSTRIAL CO.,LTD. is dedicated in Car Mirrors, Automotive Mirrors, Exterior Accessories with operations in Taiwan



DOOR MIRROR / SIDE MIRROR /
CAR MIRROR



DOOR MIRROR / SIDE MIRROR /
CAR MIRROR



DOOR MIRROR / SIDE MIRROR /
CAR MIRROR



DOOR MIRROR / SIDE MIRROR /
CAR MIRROR



TKS INDUSTRIAL CO.,LTD.

No. 47, Jhongyi 1st St., Rende Dist., Tainan City, Taiwan 717

Tel:886-6-249-2189

Fax:886-6-249-2509

E-mail: james@tagayama.com.tw

Website: m.cens.com/s/27373951

TZY KING ENTERPRISE CO., LTD.

Auto Mirrors

We are Tzy King Enterprise Co., Ltd in Taiwan. King Mirror was established since 1976 for almost 30 years long term development in Taiwan & Global marketing. We are able to provide you the best service with the make sense soonest working & delivery days. Surely we are also equipped with the best solution at a very reliable cost down price for your marketing need. «Our ambition is " Make the best quality products to meet all customers' need ". «Our quality slogan is " Completion our task on the first time presentation with 100% correction and best result" In our endeavor, we have bonded up with the potential manufacturers team for ensuring to provide the best quality products due which could come true us to pass on the cost benefit for all our dear customers. For aiming this target ,we do sincerely wish your continuing bilateral co-working & valuabl ...

TZY KING ENTERPRISE CO., LTD.

No. 12-1, Sinai Rd., South Dist., Tainan, Taiwan 702

Tel:886-6-291-8789

Fax:886-6-291-3789

E-mail: kly.king@msa.hinet.net

Website: www.cens.com/tzyking



Auto-Parts: Rear View Mirror



Auto-Parts: Rear View Mirror



Auto-Parts: Rear View Mirror



Auto-Parts: Rear View Mirror

VIEW MAX INDUSTRIAL CO., LTD.

Auto Mirrors

View Max Industrial Co., Ltd is a world-famous manufacturer of auto mirrors, mirror lamps and other related auto mirror parts. Through years of whole-hearted dedication to the auto mirror market, View Max is the leading aftermarket manufacturer of auto mirrors. We characterized by providing a wide range of auto mirrors for various automobile manufacturers around the world. Due to the higher living standard, European customers have higher demands for the quality of our products. Therefore, View Max has undergone great challenges in order to improve product quality and stability. With the principle of providing the best quality for our customers, View Max has achieved the leading position in the competitive European auto market. This great success requires View Max to keep progressive. We have further extended our products to Japanese and Korean ...

VIEW MAX INDUSTRIAL CO., LTD.

No. 36, Lane 53, Chungcheng 5th St., Yungkang Dist., Tainan City, Taiwan 710

Tel:886-6-242-2212

Fax:886-6-242-2221

E-mail: viewmax@ms34.hinet.net

Website: www.viewmax.com.tw



AUTO REAR-VIEW MIRROR



AUTO REAR-VIEW MIRROR



AUTO REAR-VIEW MIRROR



AUTO REAR-VIEW MIRROR

YONG SHENG CO., LTD.

Yongsheng, SYM, Kawasaki, E-mark, SAE, Sideview Mirrors, SpareParts, Accessories, Motorcycles, Vehicles, Sporting

Yong Sheng Co., Ltd. was established in 2000 to manufacture auto rear view mirrors. Insisting on "Customer Satisfaction, Innovation with R&D, Continual Improvement, and Responsible Operation" we will strive to do an even better job in auto mirror manufacturing in the future. All the work from design, mold creating, R&D, assembling, manufacturing, and certificate acquiring, we can all finish by ourselves. For further serving our clients, we established our Chinese factory in Gwandon Province in late 2002. * 2000 Approved by Germany's TÜV (E4, E13) * 2003 Approved by The UK's VCA (E11) * 2006 The EU Lab of our China factory was established and TÜV certified.

YONG SHENG CO., LTD.

No. 21, Lane 384, Changtsao Rd., Sec. 3, Homei Town, Changhua County, Taiwan 508

Tel:886-4-761-3366

Fax:886-4-761-3312

E-mail: yscom508@ms56.hinet.net

Website: www.yongsheng.com.tw



TOYOTA AVANZA REAR VIEW MIRROR



TOYOTA AVANZA REAR VIEW MIRROR



TOYOTA AVANZA REAR VIEW MIRROR



TOYOTA ALTIS '01 REAR VIEW MIRROR



Security Systems, Power Windows, Electronic Central Locks

TESOR PLUS CORP. 146

WEI LIANG POWER WINDOW ENTERPRISE CO., LTD. 147

WEI LIANG POWER WINDOW ENTERPRISE CO., LTD. 148

TESOR PLUS CORP.

GPS Tracking System, Smartphone Tracking & Security

TESOR is an ISO9001 certified professional manufacturer of car security alarms, immobilizers, smartphone remote control & ADAS, we own fully equipped facilities including high speed SMT, DIP and assembly production lines, with many advanced RF & digital equipment, high-low temperature/EMC-EMI magnetic & noise interference/high voltage static electricity/vibration... reliability testing equipment, etc, we do not only produce superior quality products at competitive prices, but also develop & manufacture innovative products by using new technology to create the new market. Founded in 1989 by top management professionals and expert R&D engineers, Tesor Plus Corp started with a mature and experienced team with an



TESOR PLUS CORP.

9F.-2, No.16, Jian 8th Rd., Zhonghe Dist., New Taipei City 23511, Taiwan

Tel:886-2-8226-8108

Fax:886-2-8226-8107

E-mail: alarm@tesorplus.com

Website: www.tesorplus.com



Front blind view



Smartphone Remote Control & GPS Tracker (GPS/GPRS/GSM Tracking)



Smartphone Remote Control & GPS Tracker (with 2 camera inputs)



360 view car camera and around view monitor parking assist system

WEI LIANG POWER WINDOW ENTERPRISE CO.,

Auto Power Window Regulators

Specializing in making automotive power window regulators, Wei Liang has a strong R&D team to meet every need, backed by stringent quality management and superior-quality products that are marketed worldwide and highly recognized. Providing reliable quality and all-round service, we aim to build business with customers, especially create business of higher value. We recently became ISO 9001-certified. Contact us for more information.



Power Window Regulator 2001



Power Window Regulators M



Power Window Regulators Ford Lobo



Power Window Regulators 1999-2000 JEEP Grand



WEI LIANG POWER WINDOW ENTERPRISE CO., LTD.

No.70, Ln.750, Wangfu St., Dadu Dist., Taichung City 432, Taiwan

Tel: 886-4-2693-8938

Fax: 886-4-2693-8937

E-mail: wei-liang@umail.hinet.net

Website: www.cens.com/weiliang

WEI LIANG POWER WINDOW ENTERPRISE

Auto Power Window Regulators



Power window regulator Holden Commodore VE 06-13 92191030

Specializing in making automotive power window regulators, Wei Liang has a strong R&D team to meet every need, backed by stringent quality management and superior-quality products that are marketed worldwide and highly recognized. Providing reliable quality and all-round service, we aim to build business with customers, especially create business of higher value. We recently became ISO 9001-certified. Contact us for more information.



Power Window Regulators FORD



Power Window Regulators Ford Lobo



Power Window Regulator Escape 2L8Z-7823201BA 2E11259560AD



WEI LIANG POWER WINDOW ENTERPRISE CO., LTD.

No.70, Ln.750, Wangfu St., Dadu Dist., Taichung City 432, Taiwan

Tel: 886-4-2693-8938

Fax: 886-4-2693-8937

E-mail: wei-liang@umail.hinet.net

Website: www.cens.com/weiliang



Auto Accessories

GENPLUS AUTO PARTS CO., LTD.	150
TAIR-WANG ENTERPRISE CO., LTD.	151
A-BELT-LIN INDUSTRIAL CO., LTD.	152
CAR WAY CO., LTD.	153
GOOD SUCCESS CORP.	154
HOWELL AUTO PARTS & ACCESSORIES LTD.	155
HSIN YI CHANG INDUSTRY CO., LTD.	156
KING ROOF INDUSTRIAL CO., LTD.	157
MIDOLITECH CO., LTD.	158
TAI TSUN CO., LTD.	159
TAIR-WANG ENTERPRISE CO., LTD.	160
WELLTRON ELECTRONICS CO., LTD.	161
YEEU CHANG ENTERPRISE CO., LTD.	162
ZHENG YUE ENTERPRISE CO., LTD.	163

GENPLUS AUTO PARTS CO., LTD.

Daytime Running Lights

Genplus Auto Parts Co., Ltd. was founded in 2007 Taiwan. "GENPLUS" is not just our company name but also our private brand. We are designer and manufacturer. As an auto lighting designer, we have abundant know-hows and talents in lighting optics, optical design, and lighting-fixture R&D. Also as a professional manufacturer, we provide high-quality auto lights at competitive price and shorter lead time for customers. Eco-friendly LED lighting fixtures are our main innovation and development. Our LED lighting fixtures include headlights, fog lights, sider markers, taillights, and etc., most of which comply with SAE, ECE, DOT standards. Be an ISO 9001- and TS 16949-certified company, we are committed to provide good quality, comprehensive after-sales services as well as a highly efficient manufacturing process to gain your trust a ...



GENPLUS AUTO PARTS CO., LTD.

No.139, Zhongshan Rd., Daya Dist., Taichung City, Taiwan
428

Tel:886-4-2560-1925

Fax:886-4-2560-1065

E-mail: sales@genplus.com.tw

Website: www.cens.com/genplus



Aluminium Alloy driving light



Aluminium Alloy fog light



LED Clearance Side Marker (Amber
light/ clear lens)



LED Clearance Side Marker (Amber)

TAIR-WANG ENTERPRISE CO., LTD.

Car Door Handles, Door Lock Knobs, Knock Off Spinners, License Frames, Motorcycle Accessories, Household-Use Hardware, Hardware Parts for

Tair Wang Enterprise Co.,Ltd was founded in 1978. We are a zinc die-casting manufacturer with ISO/TS 16949 approval. Our products include Harley-Davidson motorcycle parts, restoration parts for classic cars, auto parts and accessories, hardware parts, and all kinds of high quality die casting products.



Skeleton skull shift knob

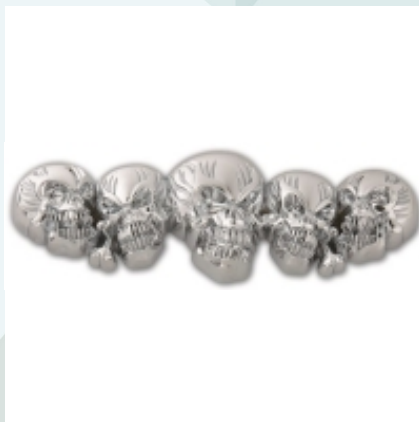

Multi skull 3D emblem



Multi skull motorcycle license frame



License frame for car

TAIR-WANG ENTERPRISE CO., LTD.

140 Yilin Rd., Jente Dist., Tainan City, Taiwan 717

Tel:886-6-279-1216/8

Fax:886-6-270-0169

E-mail: lawrence@tairwang.com

Website: www.tairwang.com

A-BELT-LIN INDUSTRIAL CO., LTD.

**Seat Safty Belt, Buckle Kinds,
Industrial Safty Belt, Tie Down,
Hardware, Lift Sling, Round Sling,
Racing Belt, Pads Kinds, Plastic**

A-BELT-LIN has experiences for manufacturing seat belt, racing belt, tow rope, tie down, industrial safety belt, lift sling ,various hardware and plastics productions for over twenty years. We also applied for many kind of certifications, which including FMVSS209/302,E Mark, CE, CNS.... etc. Our customers are all around the world. For supplying our customers in diversified requirements. We has established factories in Taiwan and Dongguan China both.



A-BELT-LIN INDUSTRIAL CO., LTD.

No. 63, Ping-an Rd., Ansi Village, Sioushuei Township,
Changhua County, Taiwan 504

Tel:886-4-768-3100

Fax:886-4-768-3940

E-mail: abeltc@ms32.hinet.net

Website: www.cens.com/abeltc



Seat Belt, Safety Belt, Auto Parts, Auto Accessories



Seat Belt, Safety Belt, Auto Parts, Auto Accessories



Seat Belt, Safety Belt, Auto Parts, Auto Accessories



Seat Belt, Safety Belt, Auto Parts, Auto Accessories

CAR WAY CO., LTD.

Power Window Regulator, Window Motor, Wiper Motor, Power Window Switch, Car Door Outside/Inside Handle

Car Way is a company established in Taiwan. We are specializing in supplying & developing of car door parts and truck spare parts. Our product range are covering window regulator(window winder/window lifter), power window switch for both driver side and passengers' side, window motor, door handles, door lock, speed sensor, bumper, grille, gasket.....all kinds of SCANIA, VOLVOBENZ TRUCK, European and Japanese truck spare parts. We have more than 6,000 items available in our current product range, "Top quality & services." is our policy and goal to achieve.



Car Door Spare Parts



Electrical Parts Flasher Relays Switches



Speed Sensor Cover

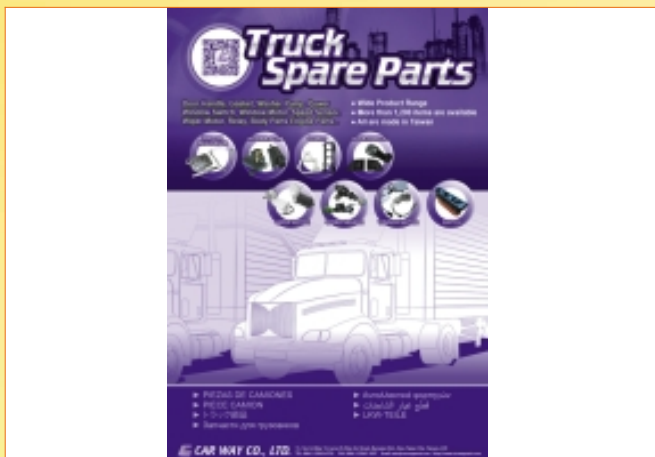

Truck Spare Parts



CAR WAY CO., LTD.

1st Fl., No. 8., Alley 10, Lane 20, Wanan St., Banqiao Dist., New Taipei City, Taiwan 220

Tel:886-2-2963-6702

Fax:886-2-2963-1897

E-mail: auto@carwayparts.com

Website: www.cens.com/carway

GOOD SUCCESS CORP.

Seat Belts, Ratchet Tie Dow, Tow Strap, Belt Sling

For more than 3 decades, we have been offering to the international market our super quality safety belts, performance car safety belts, tie down straps and tow straps. We perform the strictest quality control to ensure impeccable quality and consistence. Try us. No order is too small or too big for us.



GOOD SUCCESS CORP.

No. 54, Changma Rd., Changhua, Taiwan 50091

Tel:886-4-752-4167

Fax:886-4-752-3321

E-mail: kawahiro@ms27.hinet.net

Website: www.gscbelt.com



Safety Hook



Safety Hook



Safety Hook



Safety Hook

HOWELL AUTO PARTS & ACCESSORIES LTD.

Body Parts, Car Lamps, Gauges, Mirrors, Plastic & Rubber Parts, Auto Accessories, Head Lamp Rim, Trunk Lid Moulding, Door Mirror Cover, Rear Lamp

Established in 1994, Howell Auto Parts & Accessories Ltd. is a specialized in performance - tuning parts, auto chrome parts and accessories who is not OE follower but a performance - tuning parts designer, developer and manufacturer. Howell always insists the products high quality, reasonable prices, quickly delivery and satisfactory service. For this reason, Howell also insists his products are designed and manufactured in Taiwan due to he has a very professional R & D, quality control & inspection, manufacture and export experience organization. The company has a wide range of products - interior & exterior of chrome plated parts, aero dynamic parts and tuning parts. In ord ...



WIPER ARM COVER



WIPER ARM COVER



REAR CAMERA HOUSING



HOWELL AUTO PARTS & ACCESSORIES LTD.

No. 18-28, Lane 273, Mingchih Rd., Sec. 2, Taishan Dist., New Taipei City, Taiwan 242

Tel:886-2-8531-2727

Fax:886-2-8531-1717

E-mail: wehowell@ms23.hinet.net

Website: www.howell.com.tw

HSIN YI CHANG INDUSTRY CO., LTD.

Auto Window Visors, Hood Guard and Other Acrylic Products, Sunroof Visors, Auto Rear Sun Guards, Rigid Eyebrows

Overview: Hsin Yi Chang Industry Co., Ltd. was established in 1980. With many years' design experience, now HIC was widely known as our kindly services and delicate products. We excel in producing Window visor, Rear sun guards, Rear Roof visors, Bonnet Deflector, Sunroof deflector, auto front protective lampshades, Windshields etc. We have more than 1000 models now. Specializing in producing and serving all finished in-house, acrylic molding and other miscellaneous products. Objective: We are looking forward to join in the international competition in the future. Constantly extend ourselves to promote international image and aggressively stand on the top of Taiwan, step toward the world.



HSIN YI CHANG INDUSTRY CO., LTD.

Tel: 886-6-245-2597

Fax: 886-6-245-6085

E-mail: hic.chou@msa.hinet.net

Website: www.hic88.com.tw

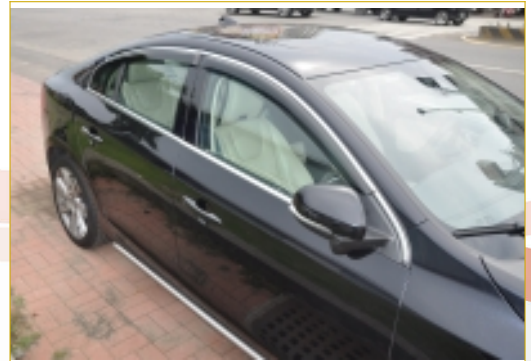

Window Visor, window Deflector, Rain Guard with chrome molding



Roof Visor, Rear Window Visor, car accessories



Chrome Bug Shield, Hood Guard, Bonnet Guard, Hood protector



Sunroof Visors/ Sunroof Deflector

KING ROOF INDUSTRIAL CO., LTD.

Bike Carrier, Roof Rack, Luggage Rack, Accessories, Dog Guard, Ski Rack, Bike Carriers

Since 1977, we are proud to have 30 years of experience in the field of bike carriers, roof racks and pet barriers. We offer the state of art equipment in manufacturing and validating bike carriers. In addition, our R&D team is comprised of highly experienced engineers who follow T.U.V. guideline to design the safest and the most innovative products. Under the new management in 2010, KingRoof has evolved from a professional manufacture into a world class center of designing, testing and manufacturing bike carriers in Taiwan.

KING ROOF INDUSTRIAL CO., LTD.

Tel:886-4-26832568

Fax:886-4-26831685

E-mail: jason.shen@kingroof.com

Website: www.bnbrack.com



Tow-ball Racks

Tow-ball Racks

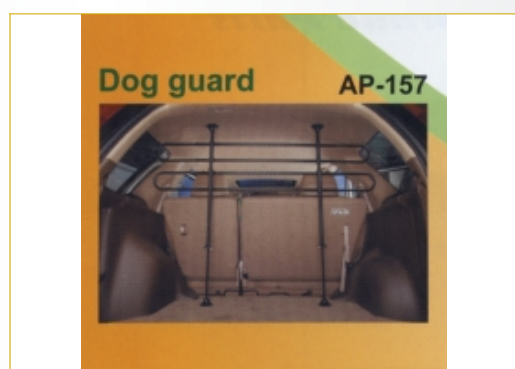

Dog Guard

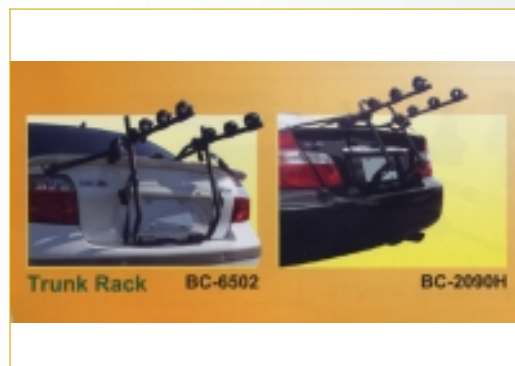

Trunk Rack



Hitch Basket

MIDOLITECH CO., LTD.

Bumper, Grille, Alloy Wheel, Spoiler, Fog Lamp, Muffler, Brake Systems

We are one of leading auto parts exporters in Taiwan, and have been exported to many clients around the world, including the items of bumper, Grille, Alloy wheel, spoiler, Fog Lamp, Muffler, and Brake systems...etc supplying parts mainly for after market service. All our products are made in Taiwan with excellent delicate work. We are able to cope with the developing new products by clients demands as well. To innovate new items is always our goal to pursuit constantly.



MIDOLITECH CO., LTD.

Rm. 4B31, No. 5, Shinyi Rd., Sec. 5, Taipei, Taiwan 110

Tel:886-2-8786-2991

Fax:886-2-8786-2992

E-mail: midoli.sphere@msa.hinet.net

Website: www.midolitech.com



DOOR MIRROR FOR EUROPEAN
CAR



DOOR MIRROR FOR EUROPEAN
CAR



DOOR MIRROR FOR EUROPEAN
CAR



Front Bumper / Body Kit

TAI TSUN CO., LTD.

Racing Car Seats, Leather Car Seat Covers, Sports Car Seats, Car Swivel Seats, Medical Car Swivel Seats

Founded in 1993, we are one of the leading professional manufacturers of car seat covers in Taiwan. We have been working on the improvement of car seating continuously and have received tremendous reputation for supplying high-quality seat covers to the local market. For the last 10 years, we have started to promote our products to foreign markets, and have proven to be affirmed by customers all over the world. With a goal to manufacture world high-quality products, we keep modifying and improving our products as per customer's request. From designing to manufacturing, we keep the strictest quality-control. In order to let customers have the most comfortable seating, we also accept custom design and modifications which are available upon customer's request. In the future, we will develop various products and manufacture a wide variety of products in this field ...



TAI TSUN CO., LTD.

No. 4, Lane 33, Jihhsin St., Tucheng Dist., New Taipei City, Taiwan 236

Tel:886-2-2274-3311

Fax:886-2-2261-8944

E-mail: frdtp@ms35.hinet.net

Website: www.frdtp.com



Leather Seat Covers

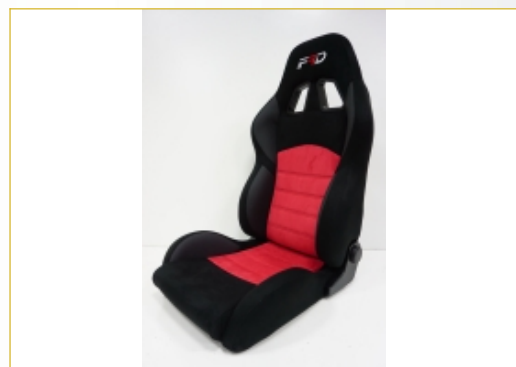

Sports Seat (SP Series)

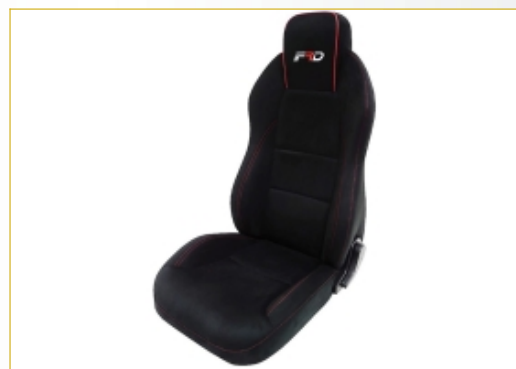

Sports Seat (FC Series)



AT Seat

TAIR-WANG ENTERPRISE CO., LTD.

Car Door Handles, Door Lock Knobs, Knock Off Spinners, License Frames, Motorcycle Accessories, Household-Use Hardware, Hardware Parts for

Tair Wang Enterprise Co.,Ltd was founded in 1978. We are a zinc die-casting manufacturer with ISO/TS 16949 approval. Our products include Harley-Davidson motorcycle parts, restoration parts for classic cars, auto parts and accessories, hardware parts, and all kinds of high quality die casting products.



Skeleton skull shift knob



Multi skull 3D emblem



Multi skull motorcycle license frame



License frame for car

TAIR-WANG ENTERPRISE CO., LTD.

140 Yilin Rd., Jente Dist., Tainan City, Taiwan 717

Tel:886-6-279-1216/8

Fax:886-6-270-0169

E-mail: lawrence@tairwang.com

Website: www.tairwang.com

WELLTRON ELECTRONICS CO., LTD.

**Power Inverters, Battery Charger,
DC-DC Converters, Portable Solar
Chargers, Modified Sine Wave
Inverter, Pure Sine Wave Inverter**

Welltron, a pioneer in power inverters and battery chargers, is your dependable manufacturer and consistent supplier of excellent. We are your dependable manufacturer and consistent supplier of excellent quality products. We strive to be a reliable partner meeting your power inverter and battery charger needs. Pure sine wave inverters With over 32 years of experience in the field of electronics, we have earned the trust and confidence of customers all over the world. Welltron's pure sine wave inverters allow motor loads to start faster. Plus, they run cooler and more quiet when compared to those operating with modified sine wave inverters. Prompt R&D response to emerging market trends We are continuously developing new products to meet existing market demands. Our R&D team is aided by machinery such as CAD, CAM, oscilloscopes and spectrum analyzers ...



WELLTRON ELECTRONICS CO., LTD.

3rd Fl.-1, No. 31-1, Lane 169, Kangning St., Shichih Dist.,
New Taipei City, Taiwan 221

Tel:886-2-2695-4637

Fax:886-2-2695-9848

E-mail: welltron@ms75.hinet.net

Website: www.welltron.com.tw



DC-DC converters



Portable solar chargers



Portable solar chargers



Power inverters

YEEU CHANG ENTERPRISE CO., LTD.

**Strobe Light, Side Light, Stop Light,
Backup Horn & Light, Interior
Light, Pole Light, Highway Flasher,
Reversing Horn, Siren Horn**

YEEU CHANG ENTERPRISE CO., LTD. was established in Taiwan from 1990 including the company and factory. We are a specialized manufacturer of Car lights and Auto accessories, that to be the ability of researching, developing, manufacturing and marketing. In order to respond to global market trend and enhance market competitiveness, we decided to set up a new factory in Jiashan County, Zhejiang Province of China in 1999. Our R & D team designs the product with function and distinguishing feature, which is our greatest competitive advantage. R & D team has the ability to design our own mold and circuit, so we can at any time cooperate with customers from concept to mold development, to do a coherent communication with the complete after-sales service, which presents we are a powerful suppliers to do OEM and ODM for the



YEEU CHANG ENTERPRISE CO., LTD.

3F., No. 168, Li De St., Jung He Dist., New Taipei City 235,
Taiwan

Tel:+886-2-3234-5050

Fax:+886-2-3234-5151

E-mail: yeeuchang@yeeuchang.com.tw

Website: www.yeeuchang.com



LED Signal Light with or without
Remote Control



LED Signal Light with or without
Remote Control

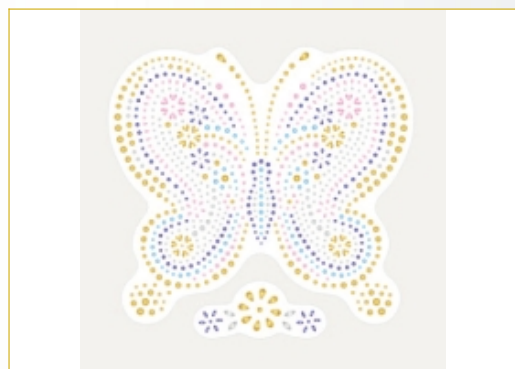

Car Stickers



LED Screw Light

ZHENG YUE ENTERPRISE CO., LTD.

Car Touch Switch, Truck Light, Day Timerunning Light, Siren Horn/Back Horn, LED Light, Car Roof Light, Side Marker, Strobe

ZHENG YUE ENTERPRISE CO., LTD was established in 1990, and are specialized in develop and manufacture Auto Accessories. As a specialist in auto decorative lights, warning lights and innovative touch switches, we have developed new products including main products , Daytime running light, Neon lights, Bumper lights, strobe lights, stop lights, side lights, Nozzels, reverse horns, mini sirens and so on, also. R & D teams of ZHENG YUE ENTERPRISE CO., LTD. Has very mightiness strength in OEM and ODM to fulfill demand of different customers. Furthermore, fast service, best quality and competitive price are top management tacit principle of ZHENG YUE ENTERPRISE CO., LTD. Looking forward to have the chance to start business relationship with any customer worldwide.



ZHENG YUE ENTERPRISE CO., LTD.

1st Fl., No. 13, Lane 193, Sammin Rd., Sec 2, Pancaio Dist., New Taipei City, Taiwan 220

Tel:886-2-2952-9666

Fax:886-2-2955-0582

E-mail: zheng.yue@msa.hinet.net

Website: www.zheng-yue.com



Auto Touch Switch



LED Rotary Warning Light



Day Time Running Light W/Indicator Light



R87 E6 0010

Day Time Running Light

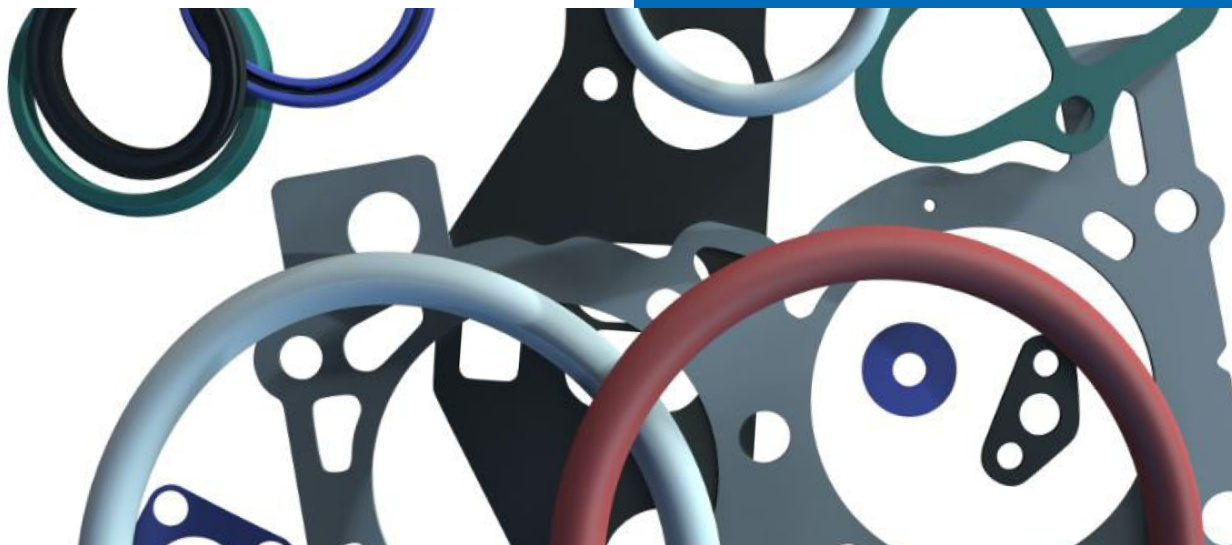

Plastic & Rubber Parts

DELTA PLASTICS CO., LTD.	165
KAI SUH SUH ENTERPRISE CO., LTD.	166
YUNGYUAN FORWARD CO., LTD.	167

DELTA PLASTICS CO., LTD.

Plastic Molds, Plastic Injection Molding, Mold, Plastic Injection Assembly, Molds, Computer Parts, Hardware Parts

1989 Established Delta Plastics Co., Ltd. 1990 Partnered with leading auto parts company 1991 Promoted and partnered with cosmetics industry 1992 Promoted and partnered with lighting industry 1993 Promoted and partnered with electronic appliance industry 1995 Trained by business consultants of 5C development 1996 Established mold department ~~~ Became a member of Taiwan Mold and Die Industry Association. (TMDIA) - Expanded business into Japanese market 1997 ISO 9002 training ~~~ Expanded Computer Peripherals sales ~~~ Receive contract with leading phone company manufacturer - ~~~ Expanded business into European market 1998 Achieved ISO 9002 Certification 1999, 2000 Expanded sales into American and



Auto Parts Molds



Auto Parts Molds



Auto Parts Molds



Auto Parts Molds

DELTA PLASTICS CO., LTD.

13 Minsheng St., Tucheng Dist., New Taipei City, Taiwan 236

Tel:886-2-2268-3625, 2268-3626

Fax:886-2-2268-1630

E-mail: fongchen@fongchen.com

Website: www.cens.com/fongchen

KAI SUH SUH ENTERPRISE CO., LTD.

**Wiring Duct, Cable Tie, Cable Marker, Cable Gland,
Cable Clamp, Cable Clip, PVC Tube**



Nylon Cable Tie



Nylon Cable Gland



Wiring Duct



EC Type Cable Marker

Kai Suh Suh Enterprise Co., Ltd. (KSS) has run business by prioritizing professionalism, quality and service for 47 years, having supplied a wide range of wiring products to over 40,000 accounts in 110 countries. Reflecting its branding success, in 2011 the globally renowned company was named a "Top 100 Taiwan Brand" by the Branding Taiwan Program spearheaded by the Taiwan External Trade Development Council (TAITRA), the semi-official trade promoter under the Ministry of Economic Affairs (MOEA) of Taiwan. The ISO 9001- and 14001-approved KSS offers a wide array of cable ties, cable ducts, markers, clamps, clips, bushings, wire connectors, PCB supports, strain-relief bushings, cooling sleeves, electronic and computer products, PCB parts, PVC insulated tubing, other electronic parts and assemblies, wiring accessories and many others. KSS-made cable ties are versatile and come ...



KAI SUH SUH ENTERPRISE CO., LTD.

38 Yenping N. Rd., Sec. 1, Taipei, Taiwan 103

Tel:886-2-2555-1929 (24 Lines)

Fax:886-2-2556-0052 (5 Lines)

E-mail: kss@mail.kss.com.tw

Website: www.cens.com/kss

YUNGYUAN FORWARD CO., LTD.

Cooling Fans, Switches, Body Electrical Parts, Wire Assemblies, Dies and Molds, Plastic Parts, Plastic Molds, Drink Holders

Since the beginning of our company's establishment in 1986, we have more than 20 years experience of manufacturing plastic and metal molds in the automotive part field. With the 20 years experience, we start to develop the quality and reliable products and manufacture by ourselves. Yungyuan Forward Co., Ltd is an international organization which offer the excellent service, best quality, on time delivery and competitive price. We are ready to provide the best service and develop the long term, successful partnerships with distributors in every market.

YUNGYUAN FORWARD CO., LTD.

No. 8, Lane 179, Sec.1, Jhongsihg Rd., Wugu Dist., New Taipei City, Taiwan 24872

Tel:886-2-2988-3902

Fax:886-2-2988-3907

E-mail: sales@yungyuan.com.tw

Website: www.yungyuan.com.tw



N75 Boost Pressure Valve



Outdoor temp. sensor



A/C control panel set caps

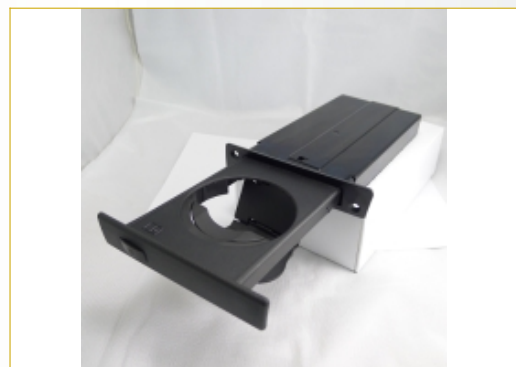

E60 front cup holder for LHD, passenger side.



Metal Forming & Processing

ELEM TECHNOLOGY CO., LTD.	169
EVER PIONEER CORP.	170
EVER PIONEER CORP.	171
NAN SHUN SPRING CO., LTD.	172
TAN KONG PRECISION TECH CO., LTD.	173
YIH FENG INDUSTRIAL CO., LTD.	174
YUN SHUOH ENTERPRISE CO., LTD.	175



Electronic parts processing

ELEM TECHNOLOGY CO., LTD.

Tel:886-4-732-4859, 737-3069
Fax:886-4-737-3611
E-mail: elem.tw@msa.hinet.net
Website: www.cens.com/elem

Founded in 1988 in central Taiwan's Changhua City, Elem is a CNC machining factory handling optical, healthcare instrument, auto, motorcycle, sniperscope, lens, and microscope parts. Equipped with precision machining centers, CNC lathes, milling machines, grinding machines, and various testing instruments, we also process, manufacture, and assemble precision electronic, optical, mechanical, and hardware c ...



OEM ODM for Electronic parts



Electronic boxes (OEM)



Electronic parts & accessories

EVER PIONEER CORP.

Office Chair Bases, Chair Backrests, Chair Mesh Backs, Chair & Table Legs, Synchronizing Mechanisms, systems Furniture

The company was founded in 1976 and started engaging in producing office chair bases on an OEM basis in 1980s. In response to customers' demand, it has continuously expanded its product portfolio to various hardware and related products since then. To enhance quality, we have introduced ISO-9001 system into its QC processes since 2008, so as to meet market demand. Presently, our product line encompasses office chair bases, backrests, mesh backs, chair legs, chair frames, table legs, systems furniture accessories, lock parts, auto body parts and accessories, engine parts & accessories, auto moldings, cable trays for photovoltaic systems, and many others.

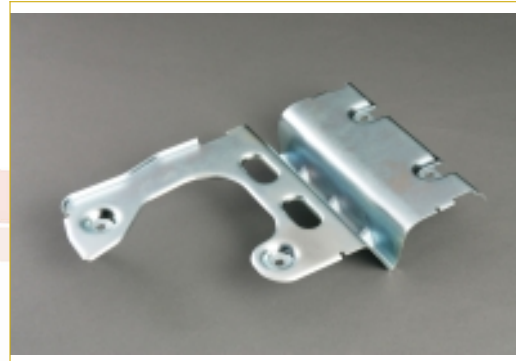

Engine Parts & Accessories

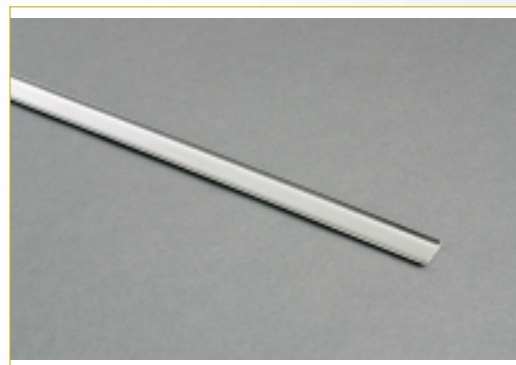

Car Decorative Stripe



Swivel Plate



Drawer Part

EVER PIONEER CORP.

NO.107, Ln. 523, Sec. 3, Jhongjheng Rd., Rende Dist.,
Tainan City 717, Taiwan

Tel:886-6-205-8779

Fax:886-6-207-1368

E-mail: ever-pioneer@ever-pioneer.com

Website: www.ever-pioneer.com

EVER PIONEER CORP.

Office Chair Bases, Chair Backrests, Chair Mesh Backs, Chair & Table Legs, Synchronizing Mechanisms, systems Furniture Accessories, Office

The company was founded in 1976 and started engaging in producing office chair bases on an OEM basis in 1980s. In response to customers' demand, it has continuously expanded its product portfolio to various hardware and related products since then. To enhance quality, we have introduced ISO-9001 system into its QC processes since 2008, so as to meet market demand. Presently, our product line encompasses office chair bases, backrests, mesh backs, chair legs, chair frames, table legs, systems furniture accessories, lock parts, auto body parts and accessories, engine parts & accessories, auto moldings, cable trays for photovoltaic systems, and many others.

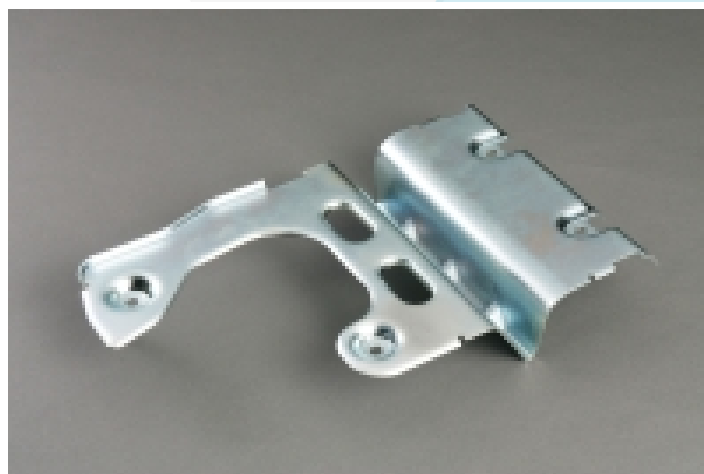

Engine Parts & Accessories

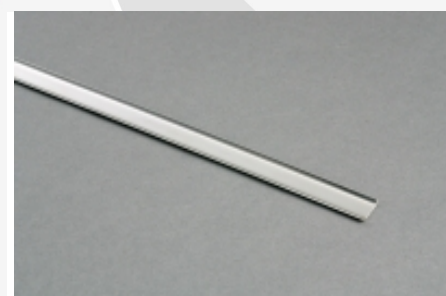

Car Decorative Stripe

EVER PIONEER CORP.

NO.107, Ln. 523, Sec. 3, Jhongjheng Rd., Rende Dist., Tainan City 717, Taiwan

Tel:886-6-205-8779

Fax:886-6-207-1368

E-mail: ever-pioneer@ever-pioneer.com

Website: www.ever-pioneer.com

NAN SHUN SPRING CO., LTD.

Precision Spring, Iron Wire Products, Electronic parts, Spring, Furniture Hardware, Hardware, Electronic and Computer Products

Established in 1987, our company is specialized in precision spring with research and design. We keep the development of our products to suit our customers' special demands and constantly research new products to fulfill markets. Our services and products have won worldwide customers' trusts, and we believe it will be your best choice! Main Products : Our company produces finest quality products which included springs/ wire forming, flats, clips, clothes hangers, hooks, rings, clamps, metal hardware parts, CNC processing products, spring leafs/ sheets, stainless steel hardware, pins, wire form bending shapes and etc. we also accepting order to produce all types of parts according to customers , sample or drawing (auto cad or pro/e 3D files). Machine Processing Equipments: Cutter Machine / Sawing Machine Grinder Machine Precision Milling M ...



NAN SHUN SPRING CO., LTD.

No. 6, Alley 63, Lane 446, Changmei Rd., Sec. 2, Tiehshan Borough, Homei Town, Changhua County, Taiwan 50848

Tel:886-4-735-9685

Fax:886-4-735-1091

E-mail: nanshun@nanshun.com.tw

Website: www.nanshun.com.tw

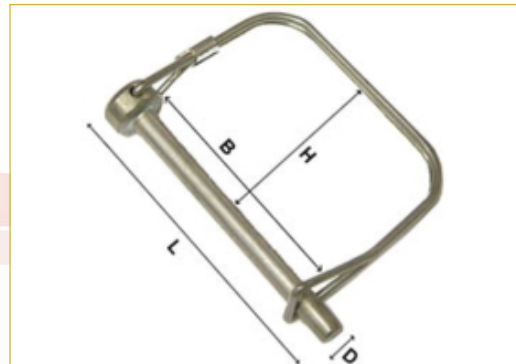

COUPLER LOCK PIN TYPE-2



Toothed Spring Pins / Powder Casing Spring Pins



Safety Pin Rings / Linch Pins / Lynch Pins



Shaft Lock Pin / Tube Clip / Linch Pin / Lynch Pin

TAN KONG PRECISION TECH CO., LTD.

Carbon Steel Ball, Chrome Steel Balls, Stainless Steel Balls, Plastic Balls, Ceramic Balls, Brass Balls, Hollow Balls

Established in 1978, Tan Kong Precision Tech Co., Ltd. has been a professional ball manufacturer and servicing the world with quality steel ball products. Our principle has always been to satisfy every client's specific requirement in terms of cost reduction, production efficiency, product quality and service. Our total factory area by the end of year 2004 is 400,000 square feet (40,000m²). Our monthly production capacity is approximately 500 metric tons of balls in various sizes. With fully automated production lines, we enjoy high production efficiency. As a token of our commitment to total quality assurance, Tan Kong has received ISO/TS 16949 certification in year 2006. Know-How Over the years, Tan Kong has developed a highly stable process control system that assures consistency at each process. Error-proofing systems are developed for each product ...



Plastic Ball



Ceramic Ball



Brass and Bronze Ball



Burnishing Media



TAN KONG PRECISION TECH CO., LTD.

No. 24, Alley 8, Lane 44, Hsinjen Rd., Sec. 1, Taiping Dist.,
Taichung City, Taiwan 411

Tel: 886-4-2278-5523

Fax: 886-4-2278-8610

E-mail: info@tankong.com

Website: www.tankong.com

YIH FENG INDUSTRIAL CO., LTD.

**Auto Parts, Motorcycle Parts,
Bicycle Parts, 3C Parts, Precision
Aluminum Alloy Forging, Die-
casting, CNC Machining**

Established in 1973, Yih Feng Industrial Co., Ltd. is an ISO 9001:2008- and ISO/TS 16949: 2009-certified company specializing in aluminum-alloy forging, die-casting, and CNC machining. We've steadily invested in technique and equipment upgrading, using the most advanced software as Master/CAM 3D and top-end equipment as CNC machining centers, enabling us to become an internationally reputed specialist in designing and making high-precision parts, and a major supplier to many international vehicle makers. In conjunction with increasing investments, we've been broadening product line to include auto, motorcycle and bicycle parts, 3C parts, sporting-goods parts, among others. Continued business development has turned us into an international supplier with three factories in Taiwan (forging, die-casting, and assembly), employing about 300 wor ...

YIH FENG INDUSTRIAL CO., LTD.

No. 159, Chungshan Rd., Sec. 1, Hwatan Township,
Changhua County, Taiwan 503

Tel:886-4-786-3866

Fax:886-4-786-9356

E-mail: yf-andrew@umail.hinet.net

Website: www.cens.com/yihfeng

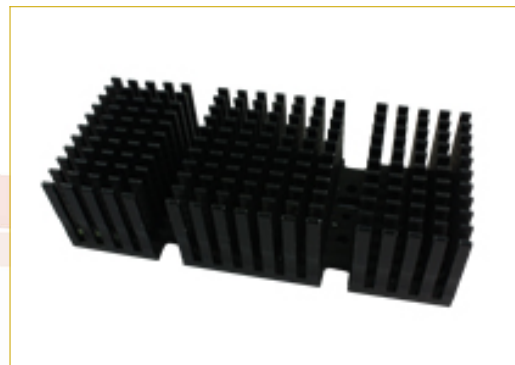

3C heat sink

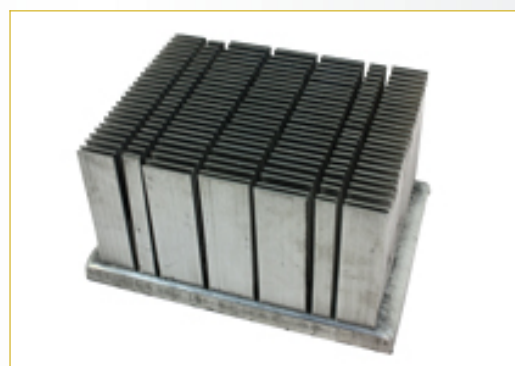

3C heat sink



3C heat sink

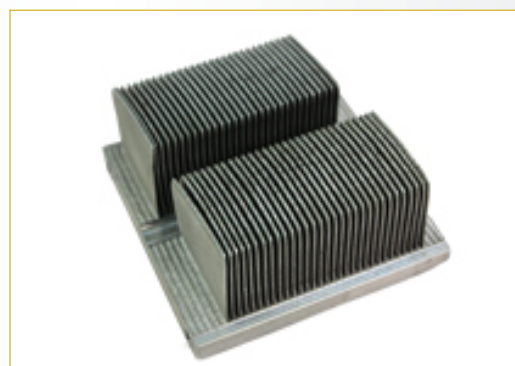

3C heat sink

YUN SHUOH ENTERPRISE CO., LTD.

**Computerized Numerical Control
Lathe Machining, All Precision
Parts, Motor shaft, electronic parts,
automobile parts**

YUN SHUOH ENTERPRISE CO., LTD. has been established since 1988. It's been 28 years which we have enjoyed a very good and valuable reputation as an esteemed firm in this field. At the very beginning, we dealt mainly with the line of traditional "Automatic Lathe" that can supply products for automotive and mechanical parts. Owing to the market trend and requests by our clients, we switched over to the computerized numerical control (CNC) lathe—milling, lathe, and Swiss type— imported from Japan to promote the efficiencies and accuracies on our products high and mostly. Today, our company has established a long-term and stable business relationship with Taiwan Power Company. We also obtain the certificate from Taiwan Power Company to produce and sell the Pressure Relief Valve of the power transformer designed by us. Additional ...

YUN SHUOH ENTERPRISE CO., LTD.

No.501-25,Wenhua Rd.,Yingge Dist.,New Taipei City 239,
Taiwan

Tel:886-2-2678-9139

Fax:886-2-2678-0953

E-mail: Vinson480628@hotmail.com

Website: www.cens.com/yunshuoh

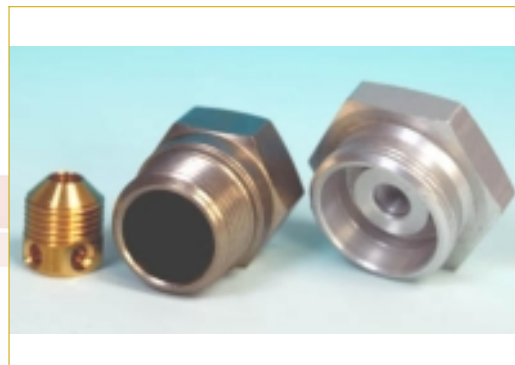

Spccial Screws, Nuts



Motor Shaft Parts



Lathe Machining Parts



Lathe Machining Parts

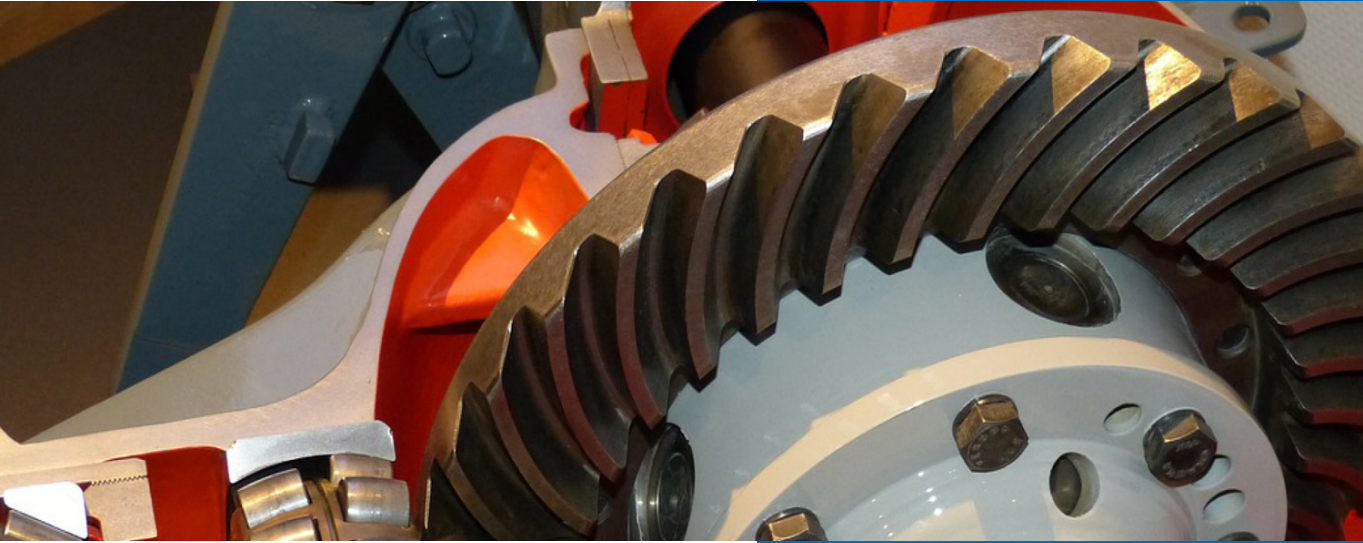

Motorcycles

ATOZ-PULLMAN CO., LTD.

177

ATOZ-PULLMAN CO., LTD.

Multi-purpose Motor Tricycle, CAFS Fire Fighting Motor Tricycle, Ambulance Motor Tricycle, Taxi Motor Tricycle

ATOZ-PULLMAN CO., LTD. is dedicated in Multi-purpose Motor Tricycle, CAFS Fire Fighting Motor Tricycle, Ambulance Motor Tricycle, Taxi Motor Tricycle, Freezer Motor Tricycle, Cargo Motor Tricycle, Vendor Motor Tricycle, Lunch Motor Tricycle, Thermal Box Motor Tricycle, Garbage Motor Tricy with operations in Taiwan



MUTLI-PURPOSE MOTOR VENDOR TRICYCLE



MUTLI-PURPOSE MOTOR TAXI TRICYCLE



MUTLI-PURPOSE MOTOR CAFS FIRE FIGHTING TRICYCLE



MUTLI-PURPOSE MOTOR AMBULANCE TRICYCLE

ATOZ-PULLMAN CO., LTD.

5F., NO.354, SEC. 1, DONGMEN RD., EAST DIST.,
TAINAN CITY 701, TAIWAN

Tel:886-6-209-4858

Fax:886-6-209-8977

E-mail: info@pullman-motor.com

Website: www.pullman-motor.com



Special-Purpose Vehicles, Parts & Accessories

SONG YERS INDUSTRIAL CO., LTD.

179

SONG YERS INDUSTRIAL CO., LTD.

**Trailer adapter, Trailer Connector,
Solenoid Switches, Truck parts, RV
connector, Trailer light converter,
Electric Wire for Trailer**

We are a manufacturer of RV trailer connectors. We also make trailer light converters and solenoid switches. If you want to choose a supplier providing the good quality and good prices, please choose Song Years. Business Type : Export, Manufacture Established In : 1975 Export Markets : Global Main Products : Trailer Connectors, License Plate Lights, Solenoid Switches Truck Parts, Trailer Wires, Trailer Light Converters, Trailer Parts, 7-way/7-pole Trailer Connectors, RV, Trailer Parts No. of Total Staff : 10-20



SONG YERS INDUSTRIAL CO., LTD.

No. 40, Lane 927, Chungshan Rd., Tsengchia Village,
Shenkang Township, Changhua County, Taiwan 509

Tel:886-4-798-2295, 799-0673

Fax:886-4-798-7933

E-mail: songyess@ms43.hinet.net

Website: www.songyers.com.tw



6- POLE TRAILER CONNECTOR
TRUCK END , METAL



6- POLE TRAILER CONNECTOR
TRAILER END , METAL , WITH



ADAPTER 7 BLADE TO 6 ROUND



ADAPTER 7 BLADE TO 5-FLAT

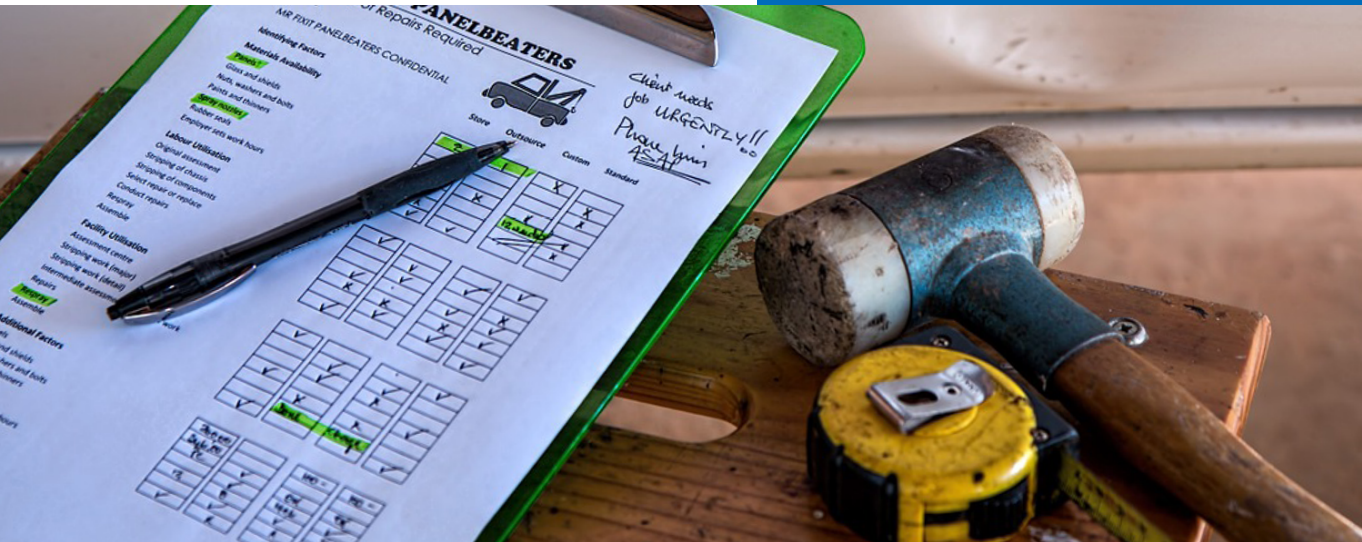

Repair Tool Kits & Equipment

APACH INDUSTRIAL CO., LTD.	181
ARCON LTD.	182
CHAIN BIN ENTERPRISE CO., LTD.	183
CHANG LOON INDUSTRIAL CO., LTD.	184
CHIA-LUNN INDUSTRIAL CO., LTD.	185
GRACE NEWS INC.	186
HANS TOOL INDUSTRIAL CO., LTD.	187
HIEVER CO., LTD.	188
KAE DIH ENTERPRISE CO., LTD.	189
LI FONG TOOL CO., LTD.	190
TSAI HSING FA CO., LTD.	191
WILLIAM TOOLS CO., LTD.	192
WILLIAM TOOLS CO., LTD.	193
YING PAIO ENTERPRISE CO., LTD.	194
ZUNG SUNG ENTERPRISE CO., LTD.	195

APACH INDUSTRIAL CO., LTD.

Air Nailer, Stapler, Air Tools, Woodworking Small Machine, Apach, Staplers, Nailers, coil nailers, framing nailers, finish

Apache is an Indian tribe in North American , according to legend , Apache was a warrior , who was brave and invincible and has been symbolized by Indians as an image of bravery and victory. This tribe has also been known for being intrepid and valiant in the Indian history. Therefore, posterity use his name for the Indian tribes named "Apache". Inheriting this tribe's spirit, Apach has been constantly devoted to developing and making top-end tools since its inception. Therefore, Apach exquisitely designs each of its nailer guns, and insists on strict durability testing of every piece of key components and parts, as well as rigid pre-delivery inspections of finished products. Just like Apache Indians who are physically strong and capable, Apach's products are durable and can endure under harsh working environments, and therefore are highly recognized and sought after ...

APACH INDUSTRIAL CO., LTD.

No. 176, Industrial 9th Rd., Tali Dist., Taichung City, Taiwan
412

Tel:886-4-2491-5576

Fax:886-4-2491-5581

E-mail: info@apach.com.tw

Website: www.apach.com.tw



Impact Wrench



Framing Nailer



Industrial Coil Nailers



Coil Nailers

ARCON LTD.

Angle Grinder, Saw Blade, TCT Saw Blade, Plastic Repair, Grease Gun, Grease Hose, Coupler, Battery Charger, Charger, Booster

Arcon Ltd. (Arcon ToolTech) is known as a product fabrication coordinator, trouble shooting and problem solution since firm is established. In first past decade, we provide product solutions from many perspectives such as engineering R&D, manufacturing process integration, quality assurance, and logistics management. With a decade of product development and continuous R&D input, we have successfully structured an independent sourcing system and manufacturing support, which drive Arcon ToolTech to provide better service to match “Made in Taiwan” product under Arcon ToolTech brand to right users along with superior quality and competitive cost in next decade.



ARCON LTD.

11F.-2, NO.88, BOGUAN RD., NORTH DIST., TAICHUNG CITY 40453, TAIWAN

Tel:886-4-2329-9208

Fax:886-4-2329-9209

E-mail: Arcon@arcontooltech.com

Website: www.cens.com/arcontooltech



Innovation
Mini Impact Wrench,Hi Torque Impact Wrench,Angle Drill Adaptor,High



Metal Working
Metal Cutter, Metal Cutting Saw, Circular Saw, Metal Cutting Circular



Working Chair
Oil Drain Pan Stand
Work Stand,Working chair,knee chair, tool stand,working stand,oil drain stand



Battery Analyser
Battery Tester,Battery Analyzer,Analyzer,Tester

CHAIN BIN ENTERPRISE CO., LTD.

Spray Gun & Pressure Tank, Auto Repair Tools. Spray Gun, Pressure Tank & Accessories, Handtools, Auto Repair Tools, Table Lamps

CHAIN BIN ENTERPRISE CO., LTD. are manufactures in Air tools (Ratchet) wrench ,Professional car repair tools ,Hydraulic press & pipe bender... Main Products/Service: Spray Gun & Pressure Tank, Auto Repair Tools. Spray Gun, Pressure Tank & Accessories, Handtools, Auto Repair Tools, Table Lamps, Decorative Lights, Wall Lamps, Tool Hardware, Spray Gun, Air Tool Specialists.



Transmission Filling system



1/4"DR. 2-25Nm ADJUSTABLE WINDOW TORQUE WRENCH

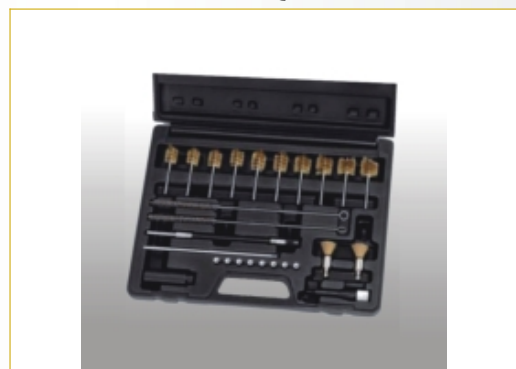

Injector Shaft Cleaning Set



Engine Timing Tools for FORD 2.0

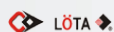

CHAIN BIN ENTERPRISE CO., LTD.

12th Fl.-2, 208-1 Wensin Rd., Sec. 4, Taichung, Taiwan 404

Tel:886-4-2299-3868

Fax:886-4-2299-3779

E-mail: chavin@ms12.hinet.net

Website: www.chainbin.com

CHANG LOON INDUSTRIAL CO., LTD.

**Bolt Cutter, Cutter, Gear Wrench,
Pro Gear Wrench, 72-teeth
Ratcheting Combination Wrench,
Tin Ship & Aviation Snip**

With some three decades in R&D and fabrication of hand tools, Chang Loon aggressively develops and offers innovative, patented items to meet changing market demands in addition to offering professional-grade ratchet wrenches and bolt cutters. Promoted globally under ProRatchet® and High Tensile brand, the aforementioned are well designed to feature higher user-friendliness, safety and labor-efficiency than conventional models. We also offer wide-ranging product lines, including professional-grade ratchet wrenches, 3-in-1 cutters and aluminum-alloy bolt cutters that are patented in Taiwan, Southeast Asia, the U.S., and Europe. Knowing that technology upgrading and going global are keys to enhancing corporate value and sustained competitiveness, our president, Chang Chung-hsing, employs the latest processing technologies and concepts from Japan and ...



CHANG LOON INDUSTRIAL CO., LTD.

349 Maming Rd., Shioushuei Township, Changhua County,
Taiwan 504

Tel:886-4-768-8568

Fax:886-4-768-8528

E-mail: proratchet@chltool.com

Website: www.chltool.com



Flexible Ratchet Combination Wrench



Ratchet Combination Wrench



Reversible Ratchet Combination Wrench



Double-Box-End Ratchet Wrench

CHIA-LUNN INDUSTRIAL CO., LTD.

4 Ton, 10 Ton, 20 Ton, Portable Power, Clamps/Collision, Repair Accessories, Hand Pumps, Air/Hydraulic Pumps, 2 Ton-100

CHIA-LUNN INDUSTRIAL CO., LTD. established in 1978 by the President-Mr. Hong and specialized in manufacturing the accessory of machinery and hydraulic pumps. From 1987, we have been specialized in designing and manufacturing the professional hydraulic equipments and tools for Auto Repairing Shop. Base on the concept of sustainable manage and keep growing up, had built up our own brand name-JACKRAM from 1999 to sell goods in the worldwide. To be much better, we had expanded the production line and succeeded in going into industrial market from 2003.



Universal Bearing Attachments Cross Bearing Pullers



Hydraulic Pullers-Package Models



Wheel Dollys



Collision Repair Kits



CHIA-LUNN INDUSTRIAL CO., LTD.

10 Industrial 3rd Rd., Touchao Industrial Dist., Mingshiung Township, Chiayi County, Taiwan 621

Tel:886-5-220-5516

Fax:886-5-220-5525

E-mail: jackram@ms26.hinet.net

Website: www.jackram.com.tw

GRACE NEWS INC.

Hand Tool Kits, Socket Set

Grace News Inc. founded in 1989 is an international supplier of high quality, professional tools based in Taiwan. With over 27 years of experience in the industry we have developed a professional reputation for our customer service and innovative products. We specialize in a wide range of hand tools as well as automotive repair tools. With a commitment to our work, the needs and requirements of our customers from across Europe, the United States and beyond have always been met and improved upon. Our mission therefore is to achieve total customer satisfaction.

GRACE NEWS INC.

5th Fl.-1, No.29, Lane 66, JuiKuang Rd., NeiHu Dist., Taipei, Taiwan

Tel:886-2-2793-6368

Fax:886-2-2790-4123

E-mail: linghsu8@gracenews.com.tw

Website: www.gracenews.ttnet.net



94PC 1/2" & 1/4" DR. SOCKET SET



21PCS BRACK SERVICE TOOL SET

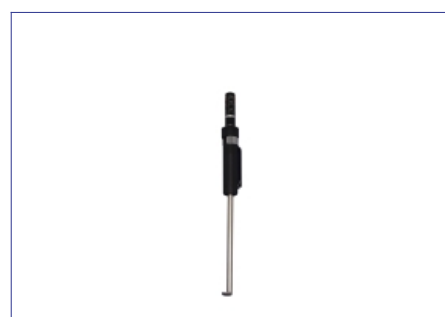

BRAKE PAD FRICTION MATERIAL MEASURING TOOL



14PC 3/4"DR. SOCKET SET

HANS TOOL INDUSTRIAL CO., LTD.

Hand Tool Kits, Wrenches/Spanners in General, Adjustable Wrenches, Socket Wrench Sets & Sockets



520pcs Tool-Trolley Group



163pcs Socker & Combination Wrench

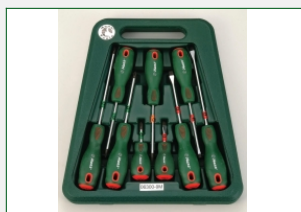

9pcs Screwdriver Sets



Tool Cabinet-8 Drawers Roll-Eagon

PROFESSIONAL Hans Tool Industrial Co., Ltd...ESTABLISHED from 1973 HANS TOOL organization is for a long-long term business that holds by Hans three directions: professional performance, complete support for your requirement and aggressive innovation. Every Hans directions committed to serving Hans families in the world be proud to be part of us and hand in hand to create a win-win long-term relationship. FOR OVER MORE THAN 1/3 A CENTURY HANS TOOL has maintained a position of leadership on manufacturing quality sockets wrench and tools over 40 years' experiences in Taiwan. Hans is specialist in making socket wrenches from 1/4 Dr.to 1", 1-1/2", 2-1/2" & 3-1/2" Dr. manual and impact 6&12 points, SAE and M.M. as well as the size form 4 mm (5/32") to 250 mm (10") above. Hans Tools supply with the wide range from over 9000 individual items and sizes ...



HANS TOOL INDUSTRIAL CO., LTD.

No. 101, Honan Rd., Sec. 2, Taichung City, Taiwan 407

Tel:886-4-2311-8682

Fax:886-4-2311-0358

E-mail: hanstool@ms23.hinet.net

Website: www.cens.com/hanstool

11 LED

11 LED Head Light w/Magnet

> HLI-311



Features:

- > IC control area with key switch in 4 parts.
- > The strong magnetic at the backboard of headlight can magnetize and fix any natural magnet articles, as a work light: repair car and machine etc.
- > LED Headlight design:
- > Put the headlight on at the forehead to be as an illuminator.
- > Convex lens has a function of magnification and focus.
- > LED lamp can save power, high brightness and long-lived.

Power:

- > AAA battery x 4pcs

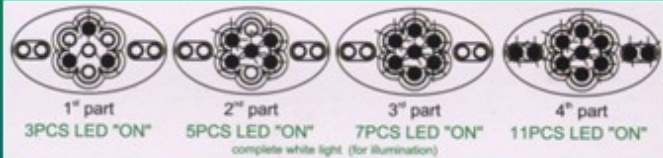

1st part 2nd part 3rd part 4th part
 3PCS LED "ON" 5PCS LED "ON" 7PCS LED "ON" 11PCS LED "ON"
 complete white light (for illumination)



LED Headlight w/Magnet

HIEVER CO., LTD.

Tel:886-4-2395-3269
 Fax:886-4-2395-3279
 E-mail: hiever78@ms66.hinet.net
 Website: www.hiever78.com

HIEVER CO; LTD was founded in 2001.04.12. A specialist manufacturer of LED lighting, including work lamps, snake (gooseneck) lights, headlights, clip lights, cap lights, etc., Hiever Co., Ltd. has a seasoned R&D team who keeps developing new items and innovates for broader LED applications, aiming to offer total lighting solutions to customers worldwide. Multi-nation-patented as well as ISO ...

3 LED Clip Light

APL-H100E

- LED lamp light bulb, energy saving, high lighting, and long service life.
- Portable light for emergency situations.
- Thermostating with automatic shut-off.
- Operation and control.

Power:

- 3xAAA battery x 3pcs



APL-H100M

- LED lamp light bulb, energy saving, high lighting, and long service life.
- Portable light for emergency situations.
- Thermostating with automatic shut-off.
- Operation and control.
- There is a powerful magnet on the top bottom.

Power:

- 3xAAA battery x 3pcs



3-LED Cap Light w/Magnet

3 LED Snake Light / Clip Light

APL-C30

- Tubular, adjustable, rigid for different posture.
- LED light bulb, energy saving, high lighting and long life.
- Lighting can be dimmed.
- Make through the car using the car's power.
- Operation and control.
- Tubular light for all lighting purposes.
- Portable, convenient, simple and safe.
- Model: 3 in a different light.

APL-C30E



3-LED Clip Light

60 LED Warn Light / Work Light

AWL-200- FR

- High Bright LED bulb is energy saving.
- Available for all lighting purposes.
- LED working for more 30,000h.
- LED Working Time: 2000h with strong magnet.
- LED Working Time: 2000h with strong magnet.
- Universal & compact design, with small form factor.
- Work in hazardous areas, such as: vehicle light, oil pit, water tank, night truck, etc.
- Long life standby, 3.6V sealed battery (3xAAA).

Power:

- 3xAAA battery x 3pcs

Plug into 12v - 10watts light

Transformer:

AWL-200- FR



60-LED Work Light/Warning Light

KAE DIH ENTERPRISE CO., LTD.

Industrial Vacuum Cleaners, Wet & Dry Vacuum Cleaners, Electric Random Orbital Sander, Spray Paint Collectors, Vacuum Cleaners

KaeDih Enterprise Co., Ltd. established in 1983, has been devoted to industrial vacuums right from the beginning. We are pioneers in the manufacturing of industrial cleaners and have taken our brand name as "JESON." We've researched and developed a wide variety of professional vacuum cleaners to fit our broad spectrum of clients in all fields. In addition to general vacuum cleaners, we also create customized cleaners for each of our customer's unique needs in order to satisfy any demand and meet all ecological requirements. KAE-DIH upholds the spirit of pursuing excellence and innovation. We seek breakthrough techniques to produce better products and actively expand the development of related manufacturing methods and products. We've cultivated our own manufacturing technique to stay ahead of the competition by continually researching and



KAE DIH ENTERPRISE CO., LTD.

No. 357, Sec.1, ChengGong Rd., Puyen Twonship, Changhua County, Taiwan 516

Tel: 886-4-865-5545

Fax: 886-4-865-5471

E-mail: sales@kaedih.com.tw

Website: www.cens.com/kaedih



JESON Products

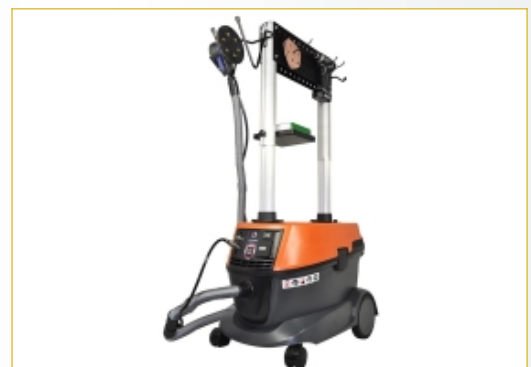

Professional Vacuum Cleaners



Professional Vacuum Cleaners



Professional Vacuum Cleaners

LI FONG TOOL CO., LTD.

Piston Ring Compressor, Piston Ring Pliers, Valve Spring Compressor

LI FONG TOOL CO., LTD. is dedicated in Piston Ring Compressor, Piston Ring Pliers, Valve Spring Compressor with operations in Taiwan



Piston Ring Compressor



Piston Ring Compressor



Piston Ring Compressor

LI FONG TOOL CO., LTD.

No. 23-2, Lane556, Chungshan Rd., Sec.1, Changhua City, Changhua County, Taiwan 50072

Tel:886-4-712-0687

Fax:886-4-712-0078

E-mail: lifongtools@gmail.com

Website: tw.myblog.yahoo.com/lifongtool-2009



Valve Spring Compressor

TSAI HSING FA CO., LTD.

Auto Repair Tools, Electrical System Repair Tool, Braking System Repair Tool



Hyundai / Kia R engine oil filter cup
wrench (PAT.)



4" Angle Grinder with
Turn Throttle



4" Angle Grinder with
Turn Throttle



Hyundai / Kia R engine oil filter cup
wrench (PAT.)

Tsai Hsing Fa Co., Ltd. is an experienced Auto Repair Tool & Equipment Exporter in Taiwan. For the past several years, Tsai Hsing Fa Co., Ltd. is always working on Automotive Repair field, try best to benefit customers' need and try to offer a fully series of Auto Repair Tool & Equipment with quality products. Under this main basic self-requirement, the clients have already webbed all over the world. The main product line includes: General Tools, Auto Repair Tool, Auto-Body Repair Tool, Engine Repair Tool, Tire Repair Tool, Electric System Repair Tool, Car Door & Window Repair Tool, Under-Car Repair Tool, Braking System Repair Too, and so on,... In October, 2006, Tsai Hsing Fa Co., Ltd. has obtained ISO9001 certification.

 AUTOMOTIVE SERVICE
TOOLS & EQUIPMENT

TSAI HSING FA CO., LTD.

No. 39, Taihe 5th St., Beitun Dist., Taichung City, Taiwan
40661

Tel:886-4-2436-8238

Fax:886-4-2436-1227

E-mail: zoids168555@gmail.com

Website: www.skautoservice.com



INDUSTRIAL TORQUE MULTIPLIER TORQUE WRENCH



THE RISING STAR AWARD



NATIONAL AWARDS OF EXCELLENCE



GOLDEN HAND AWARD



WILLIAM TOOLS CO., LTD.

No.8, Keya Road; Central Taiwan Science Park, Taichung 42881, Taiwan
TEL : 886-4-25658358 <http://www.wtools.com.tw>
FAX: 886-4-25658359 E-mail: willtool@ms34.hinet.net



WILLIAM TOOLS CO., LTD.

Torque Wrenches, Ratchet Handle, Ratchet Box Wrenches, Boat-repair Tools, Mini Round Head Ratchet Handle, Ratchet Handles

The Leading Ratchet Wrench Manufacturer Being familiar with the manufacturing process of hand tools, William Tools. Co., Ltd. has become one of the leading companies of Ratchet Handle in Taiwan and worldwide for over two decades. Mr. William Chiang, the founder of William Tools, has also engaged in hand tools manufacturing for the past 25 years, and all products we made come from his hands. Presently, we've already established our Research & Development Dept. to offer the best service to our customers, and we've also cooperated with the well-known companies like CDI, which is a subsidiary of Snap-On , to help them build the components of their Digital Torque Wrench. Furthermore, we've also helped customer design and build their own ratchet or any other unique tools since these few years, such as Rotator Ratchet for Stanley. We just w ...



WILLIAM TOOLS CO., LTD.

No. 8, Keya Rd., Central Taiwan Science Park, Taya Dist.,
Taichung City, Taiwan 428

Tel:886-4-2565-8358

Fax:886-4-2565-8359

E-mail: willtool@ms34.hinet.net

Website: www.cens.com/william



Ratchet Handles



Ratchet Handles



Ratchet Handle



Round Head Ratchet Insert

YING PAIO ENTERPRISE CO., LTD.

Tool Kits & Equipment for Vehide Repairs, Repair Tool Kits & Equipment, Repair Equipment, Repair Tool Kit, Valve

We are a professional manufacturer/supplier of tire/tube repair kits items, such as cold patch repair kits, rubber solution / cement, tire seal strips, tire/tube repair tools, tire valves, valves tubing, bicycle repair kits, tubeless tire repair kits, medical and industrial aluminum tubular. We've been in this field for over 30 years. We have own two factories which locating in Taiwan and China and our own brand such as "THUMBS UP," "DIAMON," "YP", "SUPPERCOLLE" and "NUMBER ONE," which represent the top quality and satisfied guarantee. We welcome orders of OEM & ODM. If you have any opinion, please feel free to contact us. We'll do the best for you.



Cold Patch Repair Kits



Cold Patch Repair Kits



Cold Patch Repair Kits



Tire / Tube Sealant

YING PAIO ENTERPRISE CO., LTD.

1st Fl., No. 480-2, Yenping N. Rd., Sec. 6, Taipei, Taiwan 111

Tel:886-2-2812-4515, 2812-4698

Fax:886-2-2813-3016

E-mail: yingpaio@ms17.hinet.net

Website: www.yingpaio.com.tw

ZUNG SUNG ENTERPRISE CO., LTD.

Jump Starters, Jump Start, Auto Electronic Parts, Motorcycle Flasher Relay, Circuit Breaker, LED Flasher, Solenoid Starter

We specialize in car/motorcycle flashers,, circuit breakers, start relays, wiper motors resistors,etc... We are an ISO9001: 2000 approved exporter & manufacturer of auto Parts, relay & flasher, supplier in Taiwan. ... Our product range covers DC voltage, high overload products and time-delay controller. "Short, small, light and thin" are the current trend of car electric items. With more then 15 years of anufacturing experience and the modern equipment, we have ability to produce, design and improve the products to meet customer's need.



Jump Start



Smart Jump Starter



Smart Jump Starter



ZUNG SUNG ENTERPRISE CO., LTD.

P.O. Box 544, Changhua, Taiwan 508

Tel:886-4-736-0023, 736-0024

Fax:886-4-735-5713

E-mail: zungsung@ms14.hinet.net

Website: www.cens.com/zung-sung



LED Flasher

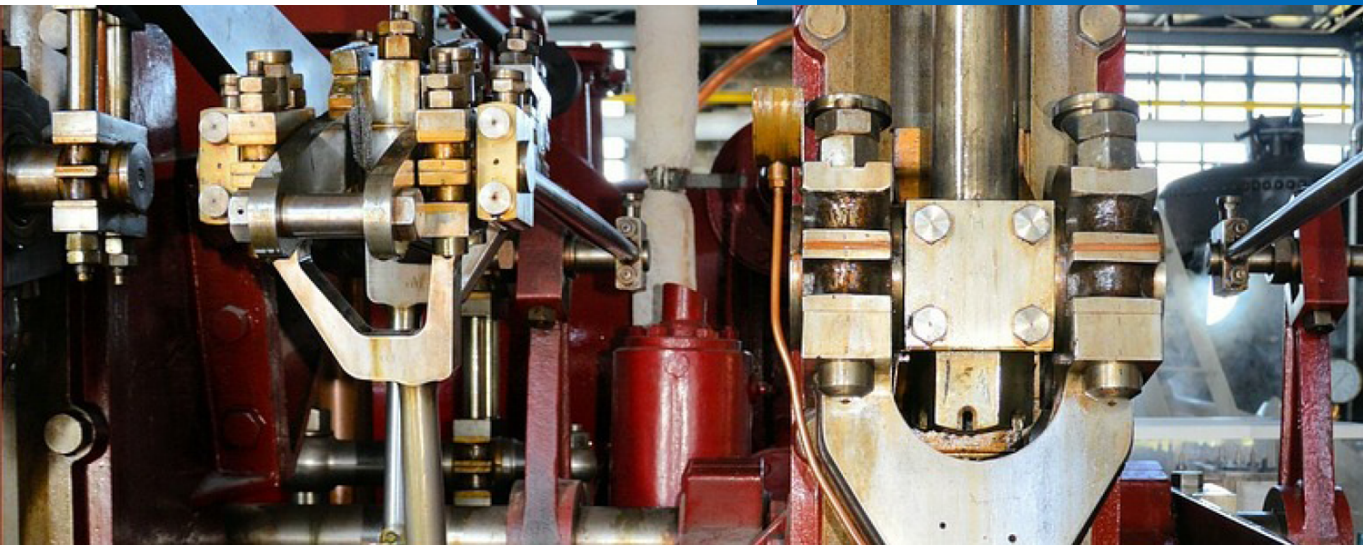

Manufacturing Equipment & Others

CHEMEX TECHNOLOGY INC.	197
TZYH RU SHYNG AUTOMATION CO., LTD.	198
CHUAN LIH FA MACHINERY WORKS CO., LTD.	199
HANN KUEN MACHINERY & HARDWARE CO., LTD.	200
JUN-EN ENTERPRISE CORP.	201
SANE JEN INDUSTRIAL CO., LTD.	202
TZYH RU SHYNG AUTOMATION CO., LTD.	203

CHEMEX TECHNOLOGY INC.

Precision Form Grinding Solutions, Impor-Machine Tools, Lace Embroidery, Plastic & Metal

Founded in 1978, CHEMEX INDUSTRIAL Co., Ltd is the sole agent of PG Optical Wheel Dresser. Specialize in Injection Molding parts, Motorcycle Mirrors, Lights & Turn Signals, OEM Rubber Parts, and most importantly, the Machinery for Brake Pad, Lining and Clutch. In 1982, CHEMEX established a manufacturing plant in Tainan specializes in precise molds and plastic injection molding products. The purpose of Tainan plant is to broaden the market of molds and plastic injection molding products outside Taiwan. Along the way, CHEMEX has been actively improving the quality of services. Except for many satisfied customers, our diligent efforts have resulted in the certification of ISO9001:2008. In ...

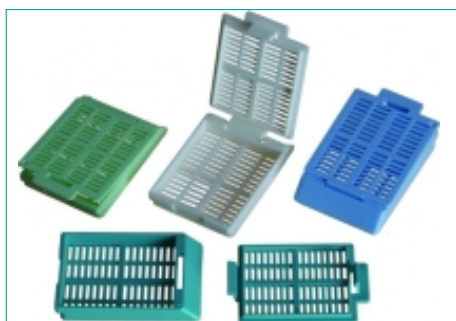

Tissue Cassette



Plastic Injection Molding Part



Brake Pad Manufacturing Plant

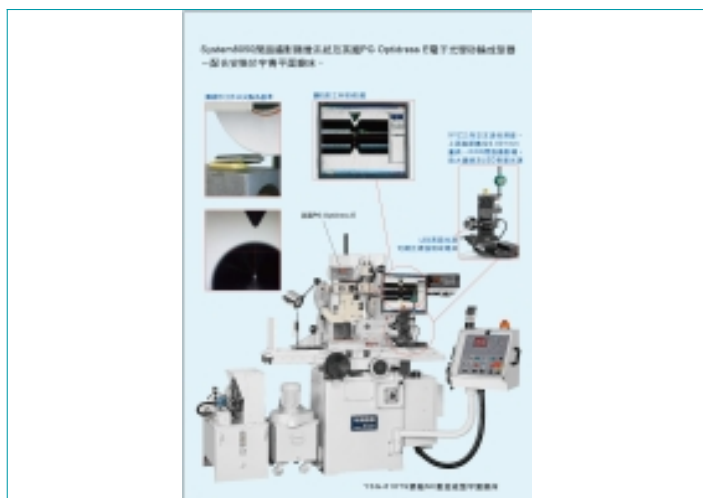

Grinding Wheel Monitoring System

CHEMEX TECHNOLOGY INC.

No. 23, Alley 2, Lane 279, ChungCheng Rd., YungKang, Tainan 71043, Taiwan

Tel:886-6-2323124

Fax:886-6-2323702

E-mail: info@chemex.com.tw

Website: www.cens.com/chemex



TZYH RU SHYNG AUTOMATION CO., LTD.

Spring Machine, Spring & Grinding Machine

Established in April 1, 1981, TRS was registered as TRS Automation Co., Ltd. The main service items are spring equipments for vehicles, such as spring machines, spring end grinding machines and peripherals. Our Coiling Machine mainly use for produce wire diameter between 0.8mm to 50.0mm, include 2 axes, 3 axes, 4 axes and 5 axes with built in CNC computerized control system to fully support various requirements of our customers. The wire capacity of spring end grinding machines is from $\phi 0.4$ ~ $\phi 50.0$ and the length of the spring from ~ 700 with numerical control (automatic compensate) and the cooling systems including air-cooling and water-cooling types. This item can be combined with spring machines and become the automatic flowing production line, which controls the quality and quantity and largely increases efficiency of products. Over many ...

TZYH RU SHYNG AUTOMATION CO., LTD.

No. 87-8, Bade 1st Rd., Renwu Dist., Kaohsiung City, Taiwan 814

Tel:+886-7-373-2588

Fax:+886-7-373-2598

E-mail: trsma@url.com.tw

Website: www.trsma.com.tw



Spring Machine

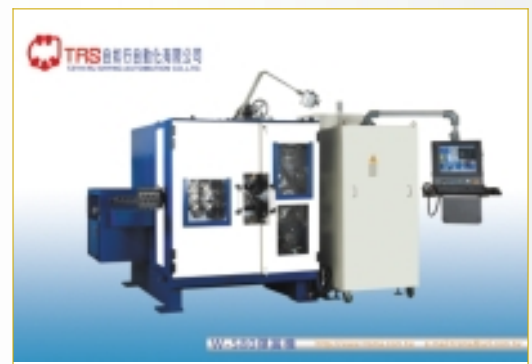

Spring Machine



Spring Machine



Spring Detector Host

CHUAN LIH FA MACHINERY WORKS CO., LTD.

Industrial Machinery, Plastic Injection Molding Machine, Other Plastic Processing Machine, Plastics Extruders

The result of more than 39 years of manufacturing experience, CLF double-toggle injection-molding machines offer a broad range of applications, consistent results, plus heavy-duty construction. Their cost advantage is largely due to the standard CLF features that competitors list as options. These apply to all CLF injection-molding machines from 50 to 4000 tons--the broadest line of its kind for your specific job applications. The clamping unit, with rigid double-toggle vertical-action design, produces a firm, even clamping force.

CHUAN LIH FA MACHINERY WORKS CO., LTD.

No. 17, Lane 360, Chungcheng S. Rd., Yungkang Dist.,
Tainan City, Taiwan 710

Tel: 886-6-595-8133#225

Fax: 886-6-253-3311

E-mail: clf@clf.com.tw

Website: www.clf.com.tw



Multi Resin/ Color Injection



Multi Resin/ Color Injection



Rigid and High Speed Injection
Molding Machine



PET Preform Series Injection Molding
Machines

HANN KUEN MACHINERY & HARDWARE CO., LTD.

SPM Units, Drilling Spindle Head Units, Machine Accessories, Boring & Milling Heads, Cross Sliding Table

Hann Kuen is a specialized manufacturer of milling spindle, drilling spindle, milling spindle units, drilling spindle units, tapping spindle units, various spindles, hydraulic slide, cutting tools and relative machinery accessories with more than 25 years' experience. Besides manufacturing, Hann Kuen also represents many well-known brands from Taiwan and worldwide, i.e. SAFEWAY- viseã€•STANNY-boring systemã€• CHANDOX-chucki¼¼ SKODA-live center from Czech Republicã€•NAREX-milling angle head from Czech Republicã€•BLAKE-centering indicator from USA etc... The body material of our boring and milling head unit is made of FC30 casting , which is under highly precision of process by boring and honing. The Alloy Steel is under process of heat-treatment as spindle parts and assembled with NSK or SKF bearing as well. Its accuracy ...



HANN KUEN MACHINERY & HARDWARE CO., LTD.

No. 22, Liou Shun Rd., East Dist., Taichung, Taiwan 401

Tel:886-4-2486-0602

Fax:886-4-2486-0605

E-mail: hann.kuen@hardy.com.tw

Website: www.cens.com/hardy



Milling Heads, Machining Spindle



Milling spindle head unit, Machining Spindle

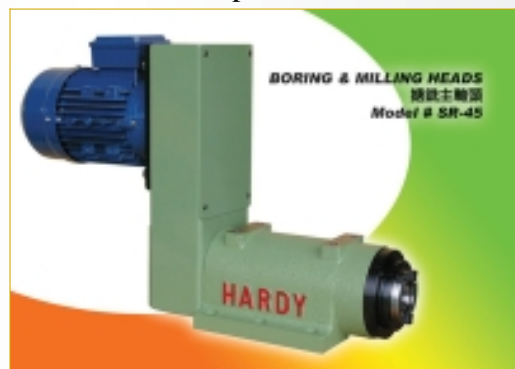

Milling spindle, Machining Spindle head



Tapping spindle hard

JUN-EN ENTERPRISE CORP.

Hy-rib Mesh Making Machine, Rib-lath Mesh Making Machine, Chain-linked Fen/CE Making Machine, Perforated Sheet Making Machine

JUN-EN, one of the leading companies in Taiwan, has been in the metal mesh industry for over twenty years. During these years, we have been servicing thousands and thousands of satisfied clients, both international and domestic. Our reputation in the industry is well recognized. In recent years, our R & D team has devoted their time and talent to designing and developing and developing of improve productivity also in adding the market of mesh machinery to our regular business lines, Because of its competitive price and high quality, our machines have been sold to many parts of the world and well acclaimed.



JUN-EN ENTERPRISE CORP.

No. 89, Bade 2nd Rd., Renwu Dist., Kaohsiung City, Taiwan 814

Tel:886-7-373-7800

Fax:886-7-373-7900

E-mail: jec@junen.com.tw

Website: www.cens.com/jun-en



C-TYPE PERFORATED METAL MACHINE

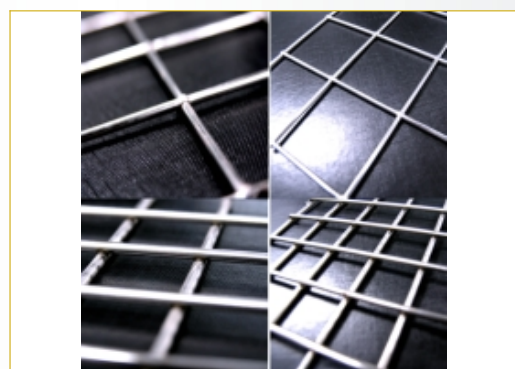

WELDED MESH



RAZOR BARBED TAPE LINE



WIRE CONVEYOR BELTING



User instructions for foldable wire containers

SANE JEN INDUSTRIAL CO., LTD.

Tel:886-5-213-4789
Fax:886-5-213-4699
E-mail: sj-storage@umail.hinet.net
Website: www.sj-storage.com.tw

Sane Jen Industrial Co., Ltd., was founded in 1984. It was specialized in developing and manufacturing folding wire containers, trolley, folding storage shelves, stacking frames, metal pallet, wire display shelves, wire decking, wire basket, wire netting... etc. for Logistics, Warehouse Storage and Supermarkets. The products made of iron wire, steel tubes, steel plate and stainless steel are also available. ...



A-3



A-5



A-7

TZYH RU SHYNG AUTOMATION CO., LTD.

Spring Machine, Spring & Grinding Machine

Established in April 1, 1981, TRS was registered as TRS Automation Co., Ltd. The main service items are spring equipments for vehicles, such as spring machines, spring end grinding machines and peripherals. Our Coiling Machine mainly use for produce wire diameter between 0.8mm to 50.0mm, include 2 axes, 3 axes, 4 axes and 5 axes with built in CNC computerized control system to fully support various requirements of our customers. The wire capacity of spring end grinding machines is from $\phi 0.4$ ~ $\phi 50.0$ and the length of the spring from ~ 700 with numerical control (automatic compensate) and the cooling systems including air-cooling and water-cooling types. This item can be combined with spring machines and become the automatic flowing production line, which controls the quality and quantity and largely increases efficiency of products. Over many ...

TZYH RU SHYNG AUTOMATION CO., LTD.

No. 87-8, Bade 1st Rd., Renwu Dist., Kaohsiung City, Taiwan
814

Tel:+886-7-373-2588

Fax:+886-7-373-2598

E-mail: trsma@url.com.tw

Website: www.trsma.com.tw



Spring Machine

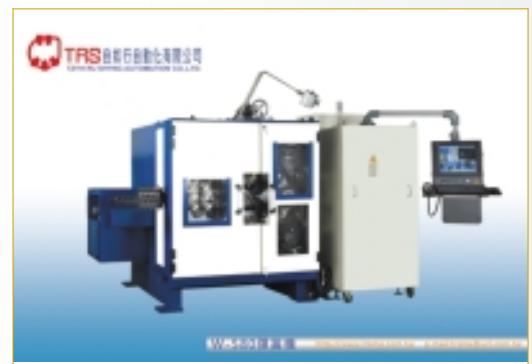

Spring Machine



Spring Machine



Spring Detector Host

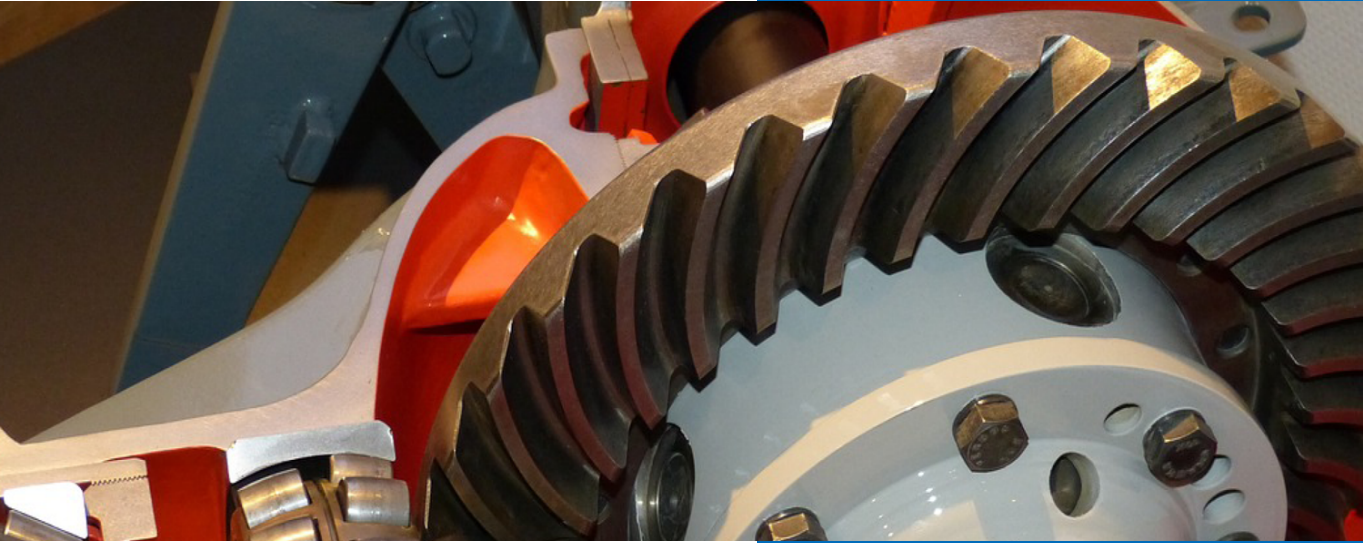

Exhibitions

INAPA 2018	205
MIMS AUTOMECHANIKA MOSCOW	206
TAIPEI AMPA 2018	207
TOOLS & HARDWARE INDONESIA 2017	208
AUTOMECHANIKA MIDDLE EAST 2018	209

Online
Product Index

Advertiser
Index

Webpage

Inquire Now

AD page



The 10th Indonesia International
Trade Show for Automotive Industry 2018



www.inapa-exhibition.net

The ASEAN's Largest International Trade Fair for Automotive Industry

22 - 24 March 2018

JIExpo Kemayoran, Jakarta - Indonesia

● AUTO GARAGE TECH



● AUTO ELECTRONICS



● AUTO ENGINEERING



● CAR WASH TECH



● FASTENER & FIXING



Held in Conjunction:



The 8th Indonesia International
Bike, Parts & Accessories
Exhibition 2018



The 3rd Indonesia International
Fastener & Fixing Technology
Exhibition 2018



The Indonesia International
Lubricants, Grease, Maintenance &
Technology Exhibition 2018



The 7th Indonesia International
Tyre, Rubber & Wheel
Exhibition 2018.



The 2nd Indonesia International Automotive
Garage Equipment, Tool, Maintenance,
Care & Services Exhibition 2018



The Indonesia International
Automotive Rechargeable Battery
Exhibition 2018

Organized by:



GEM INDONESIA
Subsidiary of GEMISEN GROUP



+62 21 54358118 (Hunting),
+62 21 54358169 / 70 / 90



+62 21 54358119



info@gem-indonesia.net



www.gem-indonesia.net

MIMS automechanika MOSCOW

21st International Exhibition of Automotive Parts, Components,
Car Maintenance Equipment and Products

21 - 24 August 2017

IEC «Expocentre»
Moscow

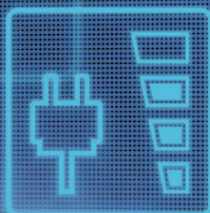
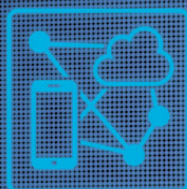

Get your free ticket at
www.mims.ru



Organizer

ITEMF
EXPO



TAIPEI AMPA

The 34th Taipei Int'l Auto Parts & Accessories Show

www.TaipeiAMPA.com.tw

Organizer:  TAITRA

Join us on 

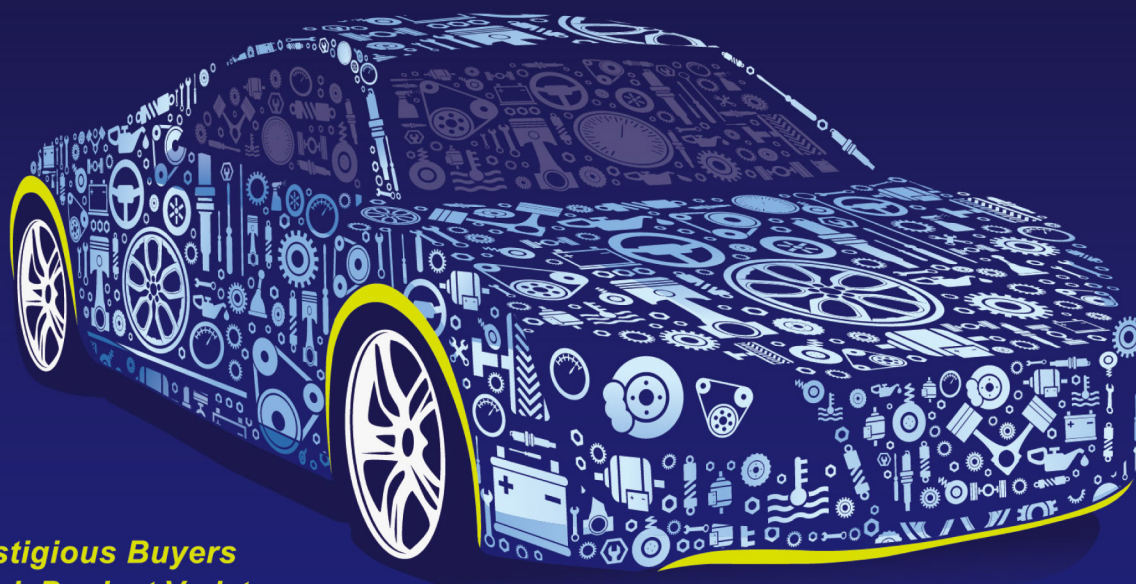

*Prestigious Buyers
Rich Product Variety
Taiwanese Customization Experts*

Where Auto Professionals Meet

Concurrent Events:

 MOTORCYCLE TAIWAN  EV TAIWAN

April 12-15, 2018 | TWTC Exhibition Hall 1



NANGANG Exhibition Center & TWTC Exhibition Hall 1
**APR.
11-14
2018**



AutoTronics Taipei

The 13th Taipei International Automobile Electronics Show

www.AutoTronics.com.tw

A PAMERINDO INDONESIA TRADE EVENT

MANUFACTURING INDONESIA 2017 SERIES

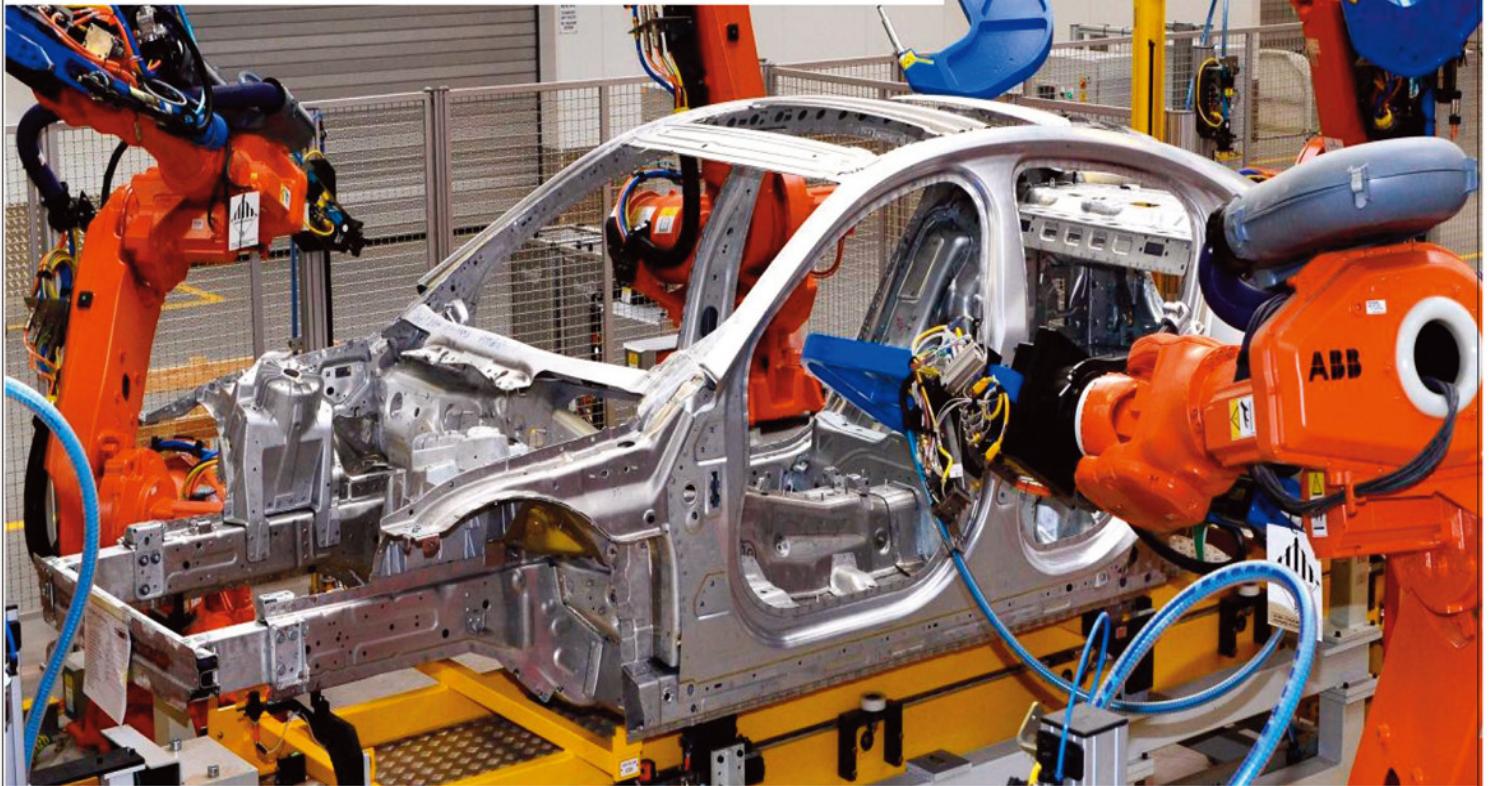

The 28th International Manufacturing Machinery, Equipment, Materials and Services Exhibitions

6 - 9 December 2017

Jakarta International Expo • Kemayoran • Indonesia



With the support of...



For further information please contact the office closest to you:



Maysia Stephanie
PT Pamerindo Indonesia
Jakarta
T: +62 21 2525 320
E: maysia@pamerindo.com



Carolyn Lee
UBM Allworld
Singapore
T: +65 6233 6777
E: Carolyn.Lee@ubm.com



Leonie Brooker
UBM Allworld
London
T: +44 20 7840 2134
E: Leonie.Brooker@ubm.com

Organised by:



www.manufacturingindonesia.com



@pamerindo



PT. Pamerindo Indonesia



PT Pamerindo Indonesia

automechanika

DUBAI

1 – 3 May 2018

www.automechanikaDubai.com

The largest international trade exhibition for the automotive service industry in the wider Middle East

Some compelling show figures:

1,955 Exhibitors

57 Exhibiting Countries

30,322 Trade Visitors

136 Visiting Countries

25 Official Country Pavilions

38 International Trade Associations

Register online to visit at www.automechanikaDubai.com/CENS



messe frankfurt



Japanese



Russian



Spanish



Portuguese



German



Arabic



Chinese



French



Persian



Vietnamese



Burmese



Thai

See more by other language



CENS Global Pass, the Newest Sourcing Tool

e-Age

Product Sourcing for Global Buyers

9 languages for global accessibility



Source in your own language
Less work but more productivity

CENS.com

buyerservice@udngroup.com.tw